

# BUYER'S GUIDE

COLLECTIONS OF YEAR 2025-2027

Main Menu



MADE FOR LIVING. WORN FOR LIFE.

It can be difficult to articulate the power of style and fashion through words, but these icons managed to do so with quote-worthy, Inspiring words of wisdom to live by



IMPACT, INFLUENCE AND INSPIRATION

Being well dressed hasn't much to do with having good clothes. It's a question of good balance and good common sense

# AUTHORIZED DISTRIBUTOR OF

Main Menu

**GILDAN**<sup>®</sup>

**ArriveGuide**<sup>®</sup>

**UnitedAthle**<sup>®</sup>

NORTH HARBOUR<sup>®</sup>

**CROSSRUNNER**<sup>®</sup>

NORTH HARBOUR<sup>®</sup>  
*Premium*

**COMFORT COLORS**<sup>®</sup>

**ANVIL**<sup>®</sup>  
BY GILDAN

**SARRA**<sup>®</sup>



# CONTENTS

COLLECTION 2025 - 2027

AG 180	CRJ 1100B	NHB 1700	NHB 3200
AG 180B	CRR 36400	NHB 1900	NHB 3300
AG 210	CRR3600B	NHB 2000	CRP 1500
AG 240	CRR 70400	NHB 2100	CRR 1100
AG 280	CRST 1100	NHB 2200	1717
AG 2316	CRST 2100	NHB 2300	858A0
AG 3220	CRSV 1100	NHB 2400	2000
CRR1300	CRSV 2100	NHB 2500	63000
CRP 1300	CRSV 3100	NHB 2700	76000
CRP 1600	HA00	NHB 3000	76000B
CRV 1700	HA40	NHB 3400	76000L
CRP 2300	NHA 1100	NHJ 5100	76400
CRP 2500	NHC 1100	NHB 24400	76600
CRP 2900	NHC 1200	NHP 82007	88000
CRJ 3100	NHO 1100	NHP 95650	88500
CRP 3100	NHT 1100	NHP 98990	88600
CRP 3200	NHT 2100	NHTB 1100	
CRR 3600	NHR 1100	NHTB 2100	
CRR 3600B	NHJ 1100	P-901	
CRR 3900	NHOH 1100	P-703	
CRR 7000	NHH 1100B	P-903	
CRR 7000B	NHR 1100B	SMW 1500	
CRP 7200	NHH 1200B	SMW 1800	
CRP 8000	NHR 11400	UA 5001-1	
CRR 36400	NHB 1400	UA 5508-01	
	NHB 1500	939	

Main Menu

## T-SHIRTS POLO

### Arrive Guide

AG 180	05
AG 210	07
AG 240	09
AG 280	11
AG 2316	13

### United Athle

UA 5001-01	15
UA 5508-01	16

### North Harbour

NHO 1100	17
NHR 1100	19

### Gildan

76000	21
76000L	23
63000	25
HA00	27
2000	29
76600	31

### Long Sleeve

NHR 11400	32
76400	33
HA 40	34

### Youth T-Shirt

AG 180B	35
NHR 1100B	37
76000B	39

### Premium Series

NHP 95650	41
NHP 82007	43
NHP 98990	45

### Short Sleeve

AG 3220	47
858A0	49
NHB 2400	51
NHB 2100	53
NHB 2200	54
NHB 2300	55
NHB 2500	56
NHB 2700	57
NHB 3200	58
NHB 3300	59

### Long Sleeve

NHB 24400	60
-----------	----

## ACTIVE POLO

CRP 8000	61
CRP 7200	63
CRP 1300	65
CRP 1600	66
CRP 2300	67
CRP 2500	68
CRP 2900	69
CRP 3100	71
CRP 3200	72

## ACTIVE TEE

### Short Sleeve & Sleeveless Tee

CRR 7000	73
CRR 3600	75
CRR 3900	77
CRR 1300	79
CRV 1700	80

### Long Sleeve Active Tee

CRR 70400	81
CRR 36400	82

### Youth Active Tee

CRR 7000B	83
CRR 3600B	85

## OUTERWEAR

### Adult Outerwear

NHJ 5100	87
NHJ 1100	89
88000	91
88500	93
88600	95
NHOH 1100	97
CRJ 3100	99

### Youth Outerwear

CRJ 1100B	101
NHH 1100B	103
NHH 1200B	105

## PREMIUM WORKWEAR

### Long Sleeve

NHB 2000	107
NHB 1400	109

### Short Sleeve

NHB 1500	110
NHB 1900	111
NHB 3000	112
NHB 3400	113

## MUSLIMAH

SMW 1500	114
SMW 1800	115

## HOMEWEAR & ACCESSORIES

### Safety Vest

CRSV 1100	117
CRSV 2100	119
CRSV 3100	120

### Apron

NHA 1100	121
----------	-----

### Cap

NHC 1100	123
NHC 1200	125

### Towel

NHT 1100	127
NHT 2100	129
CRST 1100	131
CRST 2100	133

### Tote Bag

NHTB 1100	135
NHTB 2100	137

## BEST BUY

1717	139
939	140
P-901	141
P-703	142
P-903	143
CRP 1500	144
CRR 1100	145
NHB 1700	146

Customize Info & Sublimation	147
Decorating Techniques	149
Pattern Reviews	150



## AG 180 Prime Siro Cotton Adult T-Shirt

180 g/m<sup>2</sup> (5.31 oz/yd<sup>2</sup>)  
 100% Cotton Compact Siro Yarn  
 Double needle sleeves and bottom hem  
 Tubular construction  
 Taped neck and shoulders

Rib collar  
 Tear away label  
 11 Colors  
 Sizes : XS - 5XL  
 RRP : 29.90 MYR / 11.90 SGD

Size	XS	S	M	L	XL	2XL	3XL	4XL	5XL
Chest	43	46	49	52	55	58	62	65	69
Length	64	67	69	73	75	77	80	83	85
Shoulder	39	42	45	48	51	54	58	61	64
Sleeve	21	21	21	21	21	22	22	23	23

Measurements may vary +/- 5% from actual product  
 Measurements are presented in cm





# AG 210 - Adult T-Shirt Symbolic Siro Cotton

210 g/m<sup>2</sup> (6.19 oz/yd<sup>2</sup>)  
 100% Cotton Compact Siro Yarn  
 Double needle sleeves and bottom hem  
 Side seam construction  
 Taped neck and shoulders  
 Rib collar  
 Tear away label  
 18 Colors  
 Sizes : XS - 5XL  
 RRP : 40.90 MYR / 13.90 SGD

Size	XS	S	M	L	XL	2XL	3XL	4XL	5XL
Chest	43	46	49	52	55	58	61	65	70
Length	65	67	69	73	75	77	80	83	85
Shoulder	39	42	45	48	51	54	58	61	64
Sleeve	21	21	21	21	22	22	23	23	24

Measurements may vary +/- 5% from actual product  
 Measurements are presented in cm



Crafted from comfortable and durable materials, AG 210 T-Shirts offer everything from everyday basics to bold statement pieces.





**ArriveGuide®**

# AG 240

## Ultimate Siro Cotton Oversized Fit T-Shirt

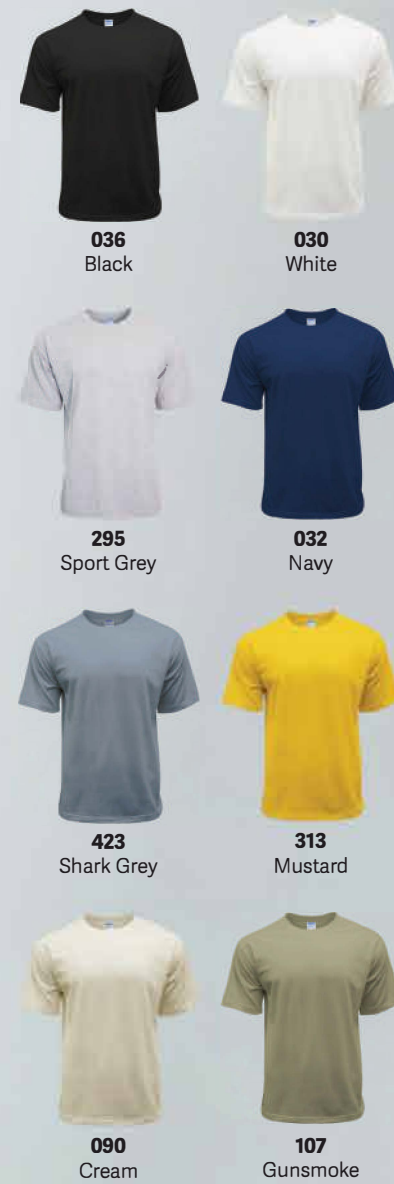

Elevate your style to a whole new level. Comfy, loose-fitting, stylish oversized cut. Suitable for multiple occasions.



240 g/m<sup>2</sup> (7.08 oz/yd<sup>2</sup>)  
 100% Cotton Compact Siro Yarn  
 Double needle sleeves and bottom hem  
 Side seam construction  
 Taped neck and shoulders  
 Smooth surface, Low hairiness  
 Rib collar  
 Oversized Fit  
 Tear away label  
 All-day comfort  
 8 Colors  
 XS - 6XL  
 RRP : 58.90 MYR / 22.90 SGD

Size	XS	S	M	L	XL	2XL	3XL	4XL	5XL	6XL
<b>Chest</b>	46	49	52	55	58	61	64	68	71	74
<b>Length</b>	62.5	65.5	69.5	72.5	75	78	80	82	84	86
<b>Shoulder</b>	41	44	47	50	53	56	59	62	65	68
<b>Sleeve</b>	18	19	20	22	24	26	27	28	28	29

Measurements may vary +/- 5% from actual product  
 Measurements are presented in cm

Main Menu

# AG 280

## Sartorial Siro Cotton Oversized Fit T-Shirt

280 g/m<sup>2</sup> (8.26 oz/yd<sup>2</sup>)  
 100% Cotton Compact Siro Yarn  
 Double needle sleeves and bottom hem  
 Side seam construction  
 Taped neck and shoulders  
 Smooth surface, Low hairiness  
 Rib collar  
 Oversized Fit  
 Tear away label  
 XS - 4XL  
 RRP : 65.90 MYR / 25.90 SGD

Size	XS	S	M	L	XL	2XL	3XL	4XL
Chest	49	52	55	58	61	64	68	72
Length	63	66	69	72	75	78	80	82
Shoulder	46	48	50	52	54	56	58	60
Sleeve	20	21	22	23	24	25	26	26

Measurements may vary +/- 5% from actual product  
 Measurements are presented in cm

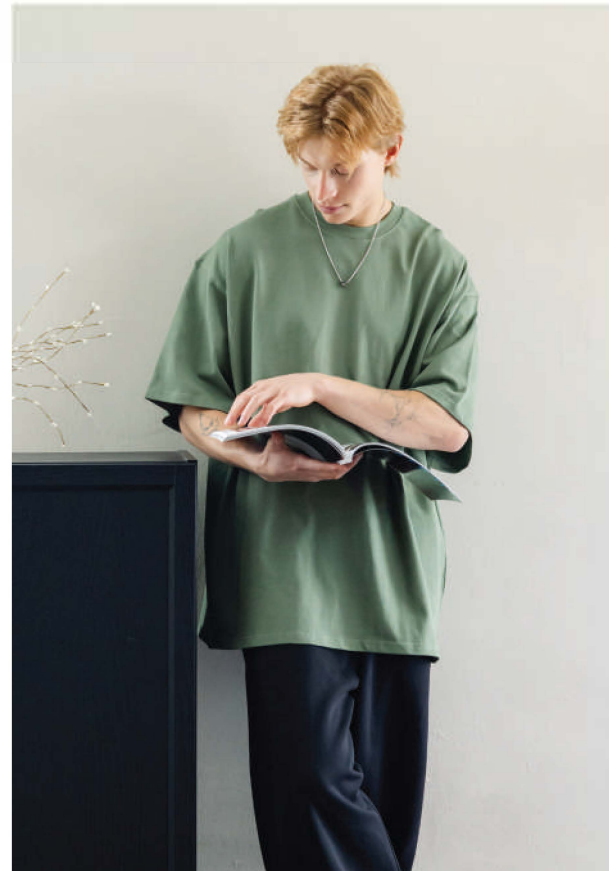

T-shirts may be simple, but with the right colour and styling tricks, you can turn something simple into a statement piece! A basic item that goes with any look.

Main Menu



# AG 2316 Vintage Snowflake Washed Tee

205 g/m<sup>2</sup>  
 100% Cotton  
 Ribbed crew neck  
 Snow-washed finish  
 Vintage and modern  
 Relaxed, timeworn charm  
 Double needle sleeves and bottom hem  
 Side seam construction  
 Taped neck and shoulders  
 Crafted from soft material  
 Tear away label  
 Sizes : S - 3XL  
 RRP : 39.90 MYR / 16.90 SGD

Size	S	M	L	XL	2XL	3XL
Chest	49	52	55	58	61	65
Length	65	68	71	74	76	78
Shoulder	47	50	53	56	59	63
Sleeve	20	21	22	23	24	25

Measurements may vary +/- 5% from actual product  
 Measurements are presented in cm



036  
Black

Designed for a vintage feel  
 Features artful fading throughout



# Crafted For The Everyday

Born from the belief that quality clothing should be effortless to find, Arrive Guide bridges timeless craftsmanship with modern affordability.

In a world of fast fashion, we choose durability, comfort, and intentional design —made accessible through thoughtful innovation.

Using advanced materials like Siro-spun yarn and organic cotton, we ensure every piece feels luxuriously soft, wears longer, and performs seamlessly—blending premium quality with everyday ease.



# UA 5001-01

## High Quality T-Shirt

### Classic Fit

190 g/m<sup>2</sup> (5.6 oz/yd<sup>2</sup>)  
 100% cotton  
 Tubular construction  
 Double needle sleeves and bottom hem  
 Taped from shoulder to shoulder  
 Double stitching on neck rib  
 Made from Semi-combed yarn  
 Rib collar  
 Sizes : S - 3XL  
 RRP : 59.90 MYR / 23.90 SGD

Size	S	M	L	XL	2XL	3XL
Chest	49	52	55	58	63	68
Length	65	69	73	77	81	84
Shoulder	42	46	50	54	57	60
Sleeve	19	20	22	24	25	26

Measurements may vary +/- 5% from actual product  
 Measurements are presented in cm



030  
White



036  
Black



# UA 5508-01

## OVERSIZED FIT T-SHIRT



UnitedAthle

190 g/m<sup>2</sup> (5.6 oz/yd<sup>2</sup>)  
 100% cotton  
 Oversized Fit  
 Side seam construction  
 Double needle sleeves and bottom hem  
 Tapes from shoulder to shoulder  
 Made from Semi-combed yarn  
 Rib collar  
 Sizes : S - 2XL  
 RRP : 69.90 MYR / 27.90 SGD

Size	S	M	L	XL	2XL
Chest	55	58	61	64	67
Length	66	70	74	78	82
Shoulder	52	55	58	61	64
Sleeve	21	23	25	27	29

Measurements may vary +/- 5% from actual product  
 Measurements are presented in cm



030  
White



036  
Black

Representative of Heavy Weight. A versatile T-shirt that can be worn alone. A piece for those who are looking for high-quality T-shirt with focus on comfort and texture It combines 3 important factors: Doesn't twist, Not see-through, and Long-lasting.

NORTH HARBOUR®

# NHO 1100

## Dynamite Oversized Crew Neck T-Shirt

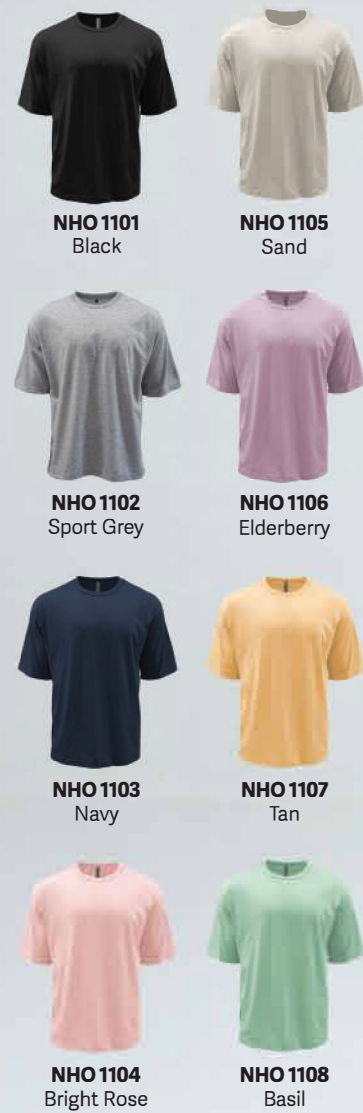

Tetron cotton single jersey  
 Round neckline, solid-toned tee  
 Extreme soft handfeel  
 Durable and breathable  
 Long lasting color  
 Anti collapse, opaque  
 Anti-pilling and wrinkle-resistant

Double needle sleeve and bottom hems  
 Fashionable half-sleeve  
 Oversized cut for a relaxed feel  
 Tear away label  
 Sizes : S - 2XL  
 RRP : 35.90 MYR / 14.90 SGD

Size	S	M	L	XL	2XL
Chest	21	22.5	24	25.5	27
Length	27	28	29	30	31
Shoulder	20	21	21.5	22	23
Sleeve	9.5	10	10.5	11	11

Measurements may vary +/- 5% from actual product  
 Measurements are presented in inches



## NHR 1100 Adult Crew Neck T-Shirt

160 g/m<sup>2</sup> (4.7 oz/yd<sup>2</sup>)  
 100% ring spun cotton preshrunk jersey knit  
 Fiber content varies by color, see color list for details  
 2cm rib collar  
 Tubular construction  
 Taped neck and shoulders

Double needle sleeve and bottom hems  
 Tear away label  
 18 colors  
 XS - 3XL (Orange, Daisy, Sport Grey, Irish Green)  
 XS - 7XL (All the rest colors)  
 RRP : 24.90 MYR / 9.90 SGD



Size	XS	S	M	L	XL	2XL	3XL	4XL	5XL	6XL	7XL
Chest	18	19	20	21	22	23	23.5	24.5	25	26	26.5
Length	26	26.5	27.5	28	29	30	30.5	31.5	32	33	33.5
Shoulder	16.5	17	18.5	19	20.5	21	22	23	23.5	24.5	25
Sleeve	7	7.5	8	8	8.5	9	9.5	9.5	10	10	10

Measurements may vary +/- 5% from actual product  
 Measurements are presented in inches

# Main Menu



## 76000 Adult T-Shirt

180 g/m<sup>2</sup> (5.3 oz/yd<sup>2</sup>)  
 100% ring spun cotton preshrunk jersey knit  
 Fiber content varies by color, see color list for details  
 2cm rib collar  
 Taped neck and shoulders  
 Double needle sleeve and bottom hems  
 Quarter-turned to eliminate center crease  
 Tear away label

XS - 5XL (Black, Navy, Red, RS Sport Grey, White)  
 XS - 3XL (All the rest colors)  
 RRP : 29.90 MYR / 11.90 SGD

Size	XS	S	M	L	XL	2XL	3XL	4XL	5XL
Chest	17	18.5	19.5	21	22	23	25	26	28
Length	25	26	27.5	28.5	29.5	30	31.5	32.5	33.5
Shoulder	15.5	17	17.5	18	19.5	20.5	21.5	22.5	23.5
Sleeve	7.5	7.5	7.5	8	8	8	8.5	8.5	8.5

Measurements may vary +/- 5% from actual product  
 Measurements are presented in inches

### 33 COLORS



# Main Menu



# 76000L Ladies T-Shirt

180 g/m<sup>2</sup> (5.3 oz/yd<sup>2</sup>)  
 100% ring spun cotton preshrunk jersey knit  
 Fiber content varies by color  
 Semi-fitted contoured silhouette with side seam  
 1.3 cm rib collar  
 Taped neck and shoulders  
 Double needle sleeve and bottom hems  
 22 colors  
 Sizes : LS - LXL  
 RRP : 29.90 MYR / 11.90 SGD

Size	LS	LM	LL	LXL
Chest	16	17	18	19
Length	23	24	25	26
Shoulder	13	13.5	14	14.5
Sleeve	5	5.5	5.5	6

Measurements may vary +/- 5% from actual product  
 Measurements are presented in inches



## BASIC FOR HER



# Main Menu



## 63000 Adult Softstyle T-Shirt

150 g/m<sup>2</sup> (4.5 oz/yd<sup>2</sup>)  
 100% ring spun cotton preshrunk jersey knit  
 Fiber content varies by color, see color list for details  
 Taped neck and shoulders  
 Double needle sleeve and bottom hems  
 Quarter-turned to eliminate center crease  
 2 cm rib collar  
 Tear away label  
 Sizes : XS - 3XL  
 RRP : 25.90 MYR / 10.90 SGD

Size	XS	S	M	L	XL	2XL	3XL
Chest	17.5	19	20	21	22	23	24
Length	25	26	27	28	29	30	30
Shoulder	15	17	18.5	19	20	21	22
Sleeve	7.5	7.5	8	8	8.5	8.5	8.5

Measurements may vary +/- 5% from actual product  
 Measurements are presented in inches



**GILDAN**  
Softstyle

# Main Menu



OEKO-TEX®  
 CONFIDENCE IN TEXTILES  
**STANDARD 100**  
 68255 OeTI  
 Tested for harmful substances  
 www.oeko-tex.com/standard100





## Heavyweight Adult T-Shirt - HA00

210 g/m<sup>2</sup> (6.1 oz/yd<sup>2</sup>)  
 100% combed ring spun cotton preshrunk jersey knit  
 High stitch density for smoother printing surface  
 2.3 cm rib collar, Classic Fit  
 Taped neck and shoulders

2 cm double-needle sleeve and bottom hems  
 Quarter-turned to eliminate center crease  
 Tear away label  
 XS - 3XL  
 RRP : 34.90 MYR / 13.90 SGD



268 C  
Berry

Size	XS	S	M	L	XL	2XL	3XL
Chest	17	18.5	19.5	21	22	23	25
Length	25	26	27.5	28.5	29.5	30	31.5
Shoulder	15.5	17	17.5	18	19.5	20.5	21.5
Sleeve	7.5	7.5	7.5	8	8	8	8.5

Measurements may vary +/- 5% from actual product  
 Measurements are presented in inches

Perfect for daily types! A heavyweight T-shirt with a slightly fitted look. Fiber content varies by color, see color list for details.

## 13 COLORS





**ULTRA COTTON**  
simple made better

# 2000 Adult T-Shirt

203 g/m<sup>2</sup> (6.0 oz/yd<sup>2</sup>)  
 100% cotton preshrunk jersey knit  
 Fiber content varies by color, see color list for details  
 Quarter-turned to eliminate center crease  
 Tear away label  
 Seamless double-needle 2.2 cm collar  
 Taped neck and shoulders  
 Double needle sleeve and bottom hems  
 S - 2XL (Military Green, Heather Navy, Heather Sapphire)  
 S - 3XL (Red, Charcoal, Royal, Dark Heather)  
 S - 5XL (White, Black, Navy, Sport Grey)  
 RRP : 34.90 MYR / 13.90 SGD

**11**  
COLORS



**30 N**  
White



**36 C**  
Black



**40 C**  
Red



**51 C**  
Royal



**217 C**  
Heather Sapphire  
(50C/50P)



**32 C**  
Navy



**106 C**  
Military Green



**170 C**  
Heather Navy  
(50C/50P)



**108 C**  
Dark Heather  
(50C/50P)



**295 H**  
RS Sport Grey  
(90C/10P)



**42 C**  
Charcoal

Size	S	M	L	XL	2XL	3XL	4XL	5XL
Chest	18	20	22	24	26	28	30	32
Length	28	29	30	31	32	33	34	35
Shoulder	16	18	21	22	24	26	28	29
Sleeve	6	6.5	7	7.5	7.5	8	8.5	9

Measurements may vary +/- 5% from actual product  
 Measurements are presented in inches





# 76600 Adult Ringer T-Shirt

180 g/m<sup>2</sup> (5.3 oz/yd<sup>2</sup>)  
 100% ring spun cotton preshrunk jersey knit  
 Double needle bottom hem  
 Contrast neck and sleeve bands  
 Quarter-turned to eliminate center crease  
 Tear away label  
 7 colors combinations  
 Sizes : XS - 2XL  
 RRP : 32.90 MYR / 13.90 SGD

Size	XS	S	M	L	XL	2XL
Chest	17	18.5	19.5	21	22	23
Length	25	26	27.5	28.5	29.5	30
Shoulder	15.5	17	17.5	18	19.5	20.5
Sleeve	7.5	7.5	8	8	8.5	8.5

Measurements may vary +/- 5% from actual product  
 Measurements are presented in inches



NORTH HARBOUR®

# NHR 11400 Long Sleeve T-Shirt

160 g/m<sup>2</sup> (4.7 oz/yd<sup>2</sup>)  
 100% ring spun cotton preshrunk jersey knit  
 Fiber content varies by color, see color list for details  
 2cm rib collar  
 Tubular construction  
 Taped neck and shoulders  
 Double needle sleeve and bottom hems  
 Tear away label  
 Sizes : S - 3XL  
 RRP : 27.90 MYR / 11.90 SGD



Size	S	M	L	XL	2XL	3XL
Chest	19	20	21	22	23	24
Length	26.5	27.5	28	29	30	31
Shoulder	17	18	19	20	21	22
Sleeve	21.5	22	22.5	23	23.5	24

Measurements may vary +/- 5% from actual product  
 Measurements are presented in inches



# 76400

## ADULT LONG SLEEVE T-SHIRT



**GILDAN**  
PREMIUM  
Cotton™

180 g/m<sup>2</sup> (5.3 oz/yd<sup>2</sup>)  
100% ring spun cotton preshrunk jersey knit  
Fiber content varies by color  
2 cm rib collar  
Taped neck and shoulders  
Double needle sleeve and bottom hems  
Quarter-turned to eliminate center crease  
5 colors  
Tear away label  
Sizes : XS - 2XL  
RRP : 32.90 MYR / 13.90 SGD

Size	XS	S	M	L	XL	2XL
Chest	17	18.5	19.5	21	22	23
Length	25	26	27	28	29	30
Shoulder	15.5	17	17.5	18	19.5	21
Sleeve	22.5	23	23.5	24	24.5	25

Measurements may vary +/- 5% from actual product  
Measurements are presented in inches



**GILDAN**  
HAMMER

# HA40

## Adult Long Sleeve T-Shirt

210 g/m<sup>2</sup> (6.1 oz/yd<sup>2</sup>)  
100% combed ring spun cotton preshrunk jersey knit  
Fiber content varies by color, see color list for details  
High stitch density for smoother printing surface  
2.3 cm rib collar, Rib cuffs  
Taped neck and shoulders  
2 cm double needle bottom hem  
Quarter-turned to eliminate center crease  
Tear away label  
4 colors  
Sizes : XS - 2XL  
RRP : 39.90 MYR / 16.90 SGD

Size	XS	S	M	L	XL	2XL
Chest	17	18.5	19.5	21	22	23
Length	25	26	27.5	28.5	29.5	30
Shoulder	15.5	17	17.5	18	19.5	20.5
Sleeve	21	22	23	23.5	24.5	25

Measurements may vary +/- 5% from actual product  
Measurements are presented in inches



Main Menu

# AG 180B

## Prime Siro Cotton Youth T-Shirt

180 g/m<sup>2</sup> (5.31 oz/yd<sup>2</sup>)  
 100% Cotton Compact Siro Yarn  
 Double needle sleeves and bottom hem  
 Side seam construction  
 Taped neck and shoulders  
 Rib collar  
 Tear away label  
 Sizes : 4 ( 100 ) - 9 ( 150 )  
 RRP : 26.90 MYR / 10.90 SGD

Size	4 (100)	5 (110)	6 (120)	7 (130)	8 (140)	9 (150)
Chest	35.5	38	40.5	43	45.5	48
Length	48	51	54.5	58.5	62	66
Shoulder	32	34.5	37	39.5	42	44.5
Sleeve	14	15	16.5	18	19	20

Measurements may vary +/- 5% from actual product  
 Measurements are presented in cm



Main Menu



ArriveGuide®

ArriveGuide®



SIMPLE AND NATURAL



Youth Crew Neck T-Shirt  
 160 g/m<sup>2</sup> (4.7 oz/yd<sup>2</sup>)  
 100% ring spun cotton preshrunk jersey knit  
 Fiber content varies by color, see color list for details  
 1.5 rib collar  
 Sideseamed  
 Taped neck and shoulders  
 Double needle sleeve and bottom hems  
 Tear away label  
 7 colors  
 Sizes : YXS - YXL  
 RRP : 24.90 MYR / 10.90 SGD

## NHR 1100B Youth T-Shirt



Size	YXS	YS	YM	YL	YXL
Chest	12	13	14	15	16
Length	15.5	18	20	21.5	23.5
Shoulder	11	12	13	14	15
Sleeve	4.5	5	5.5	6	6.5

Measurements may vary +/- 5% from actual product  
 Measurements are presented in inches

# 76000B Youth T-Shirt

Adorable yet comfortable

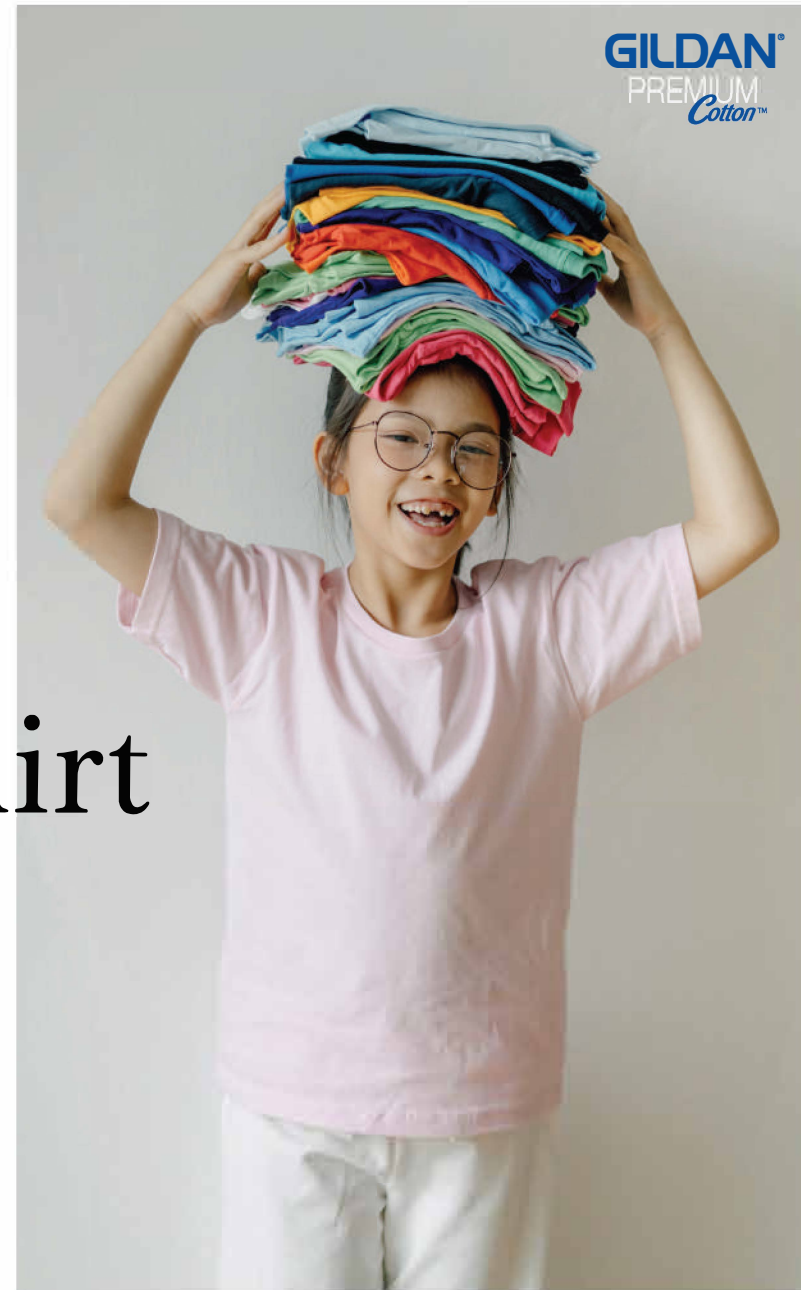

Size	YXS	YS	YM	YL	YXL
Chest	13	14	15	16	17
Length	17.5	19	20	21	22.5
Shoulder	11	12	13	14	15
Sleeve	5	5.5	6	6.5	7

Measurements may vary +/- 5% from actual product  
Measurements are presented in inches

180 g/m<sup>2</sup> (5.3 oz/yd<sup>2</sup>)  
100% ring spun cotton preshrunk jersey knit  
Fiber content varies by color, see color list for detail  
1.5 cm rib collar  
Sideseamed  
Taped neck and shoulders  
Double needle sleeve and bottom hems  
CPSIA tracking label compliant  
Tear away label  
19 colors  
Sizes : YXS - YXL  
RRP : 26.90 MYR / 10.90 SGD



Fun t-shirts for boys & girls,  
ideal for every occasion;  
comfort to complete any outfit  
for more relaxed days.



 <b>98 C</b> Daisy	 <b>24 C</b> Gold	 <b>37 C</b> Orange	 <b>12 C</b> Lime
 <b>167 C</b> Irish Green	 <b>20 C</b> Light Pink	 <b>71 C</b> Azalea	 <b>10 C</b> Heliconia
 <b>40 C</b> Red	 <b>69 C</b> Light Blue	 <b>109 C</b> Carolina Blue	 <b>26 C</b> Sapphire
 <b>51 C</b> Royal	 <b>765 C</b> Sport Royal	 <b>81 C</b> Purple	 <b>32 C</b> Navy
 <b>30 N</b> White	 <b>295 H</b> RS Sport Grey (90C/10P)	 <b>36 C</b> Black	

Main Menu



Size	S	M	L	XL	2XL	3XL	4XL	5XL	6XL
Chest	47	49	51	53	55	57	59	61	63
Length	64	66	68	70	72	73	74	75	76
Shoulder	42	43.5	45	46.5	48	49.5	51	52.5	54
Sleeve	20	20.5	21	21.5	22	22.5	23	23.5	24

Measurements may vary +/- 5% from actual product  
Measurements are presented in cm



The collar shape is snug and maintains its form.

Elegant and meticulously crafted with three buttons.

The perfect combination of exquisite craftsmanship.

Chain stitching is neat, precise, and firm.

Double stitching on hem.

NORTH HARBOUR®  
Premium

Main Menu

# NHP 95650 Lumin Polo

50% Polyester 45% Cotton 5% Spandex  
Weight : 200 gsm  
Simple and elegant snug collar design  
Elegant & Exquisite three buttons  
Exquisite craftsmanship and soft fabrics cuffs  
Chain stitching is more neat, precise and firm  
Double-needle bottom hem  
Clean and comfortable fit  
Woven Label  
Sizes : S - 6XL  
RRP : 69.90 MYR / 29.90 SGD





Suitable for both casual and formal everyday occasions.

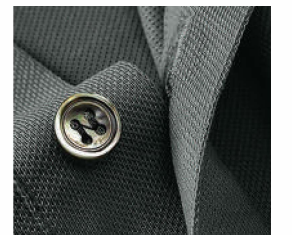

Subtle texture that showcases a relaxed and effortless casual style.



Well-fitted, refined, and stylish.

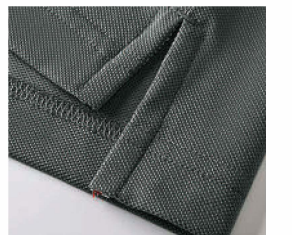

The hem slit design embellishes the clothes, adding a fashionable touch.

69.4% Cotton 25.5% Polyester 5.1% Spandex  
 Weight : 200 gsm  
 Snug collar design  
 Wrinkle-resistant, easy-care fabric  
 Eco-friendly natural dyes  
 Breathable and moisture-permeable function  
 Natural fabrics, Long staple cotton  
 Soft feel and comfortable  
 Ice silk & Elastic fibers  
 Woven Label  
 Sizes : S - 6XL  
 RRP : 79.90 MYR / 35.90 SGD

## NHP 82007 Eminent Polo



Size	S	M	L	XL	2XL	3XL	4XL	5XL	6XL
Chest	49	51	53	55	57	59	61	63	65
Length	65	67	69	71	73	75	77	78	78
Shoulder	43	44.5	46	47.5	49	50.5	52	53.5	55
Sleeve	21	21.5	22	22.5	23	23.5	24	24.5	25

Measurements may vary +/- 5% from actual product  
 Measurements are presented in cm



036  
Black



031  
Off White



326  
Ice Blue



032  
Navy



561  
Matcha



038  
Sand



Suitable for both casual and formal occasions.

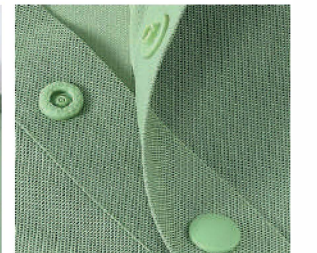

Designed with snap buttons for effortless fastening.

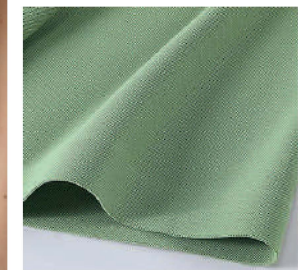

The well-tailored fit offers a sharp, refined silhouette.



With vibrant colors, a comfortable hand feel, and excellent drape, it embodies both style and quality.

## NHP 98990 Noble Polo

Fabric : Dynamic Piqué  
Weight : 165 gsm  
86.3% Nylon, 13.7% Spandex  
Seamless Technology  
Cool-to-the-Touch Sensation  
5A Grade Antibacterial Protection  
Snap button closure  
Soft and Comfortable, Natural Fabric  
Skin-Friendly and Breathable  
Small side slits on the hems, Straight hem  
Woven Label



Seamless  
craftsmanship



Wrinkle-resistant &  
easy to care for



Smooth &  
soft to the touch

Sizes : S - 6XL  
RRP : 75.90 MYR / 32.90 SGD

Size	S	M	L	XL	2XL	3XL	4XL	5XL	6XL
Chest	47	49	51	53	55	57	59	61	63
Length	65	67	69	71	73	74	75	76	77
Shoulder	42	43.5	45	46.5	48	49.5	51	52.5	54
Sleeve	21	21.5	22	22.5	23	23.5	24	24.5	25

Measurements may vary +/- 5% from actual product  
Measurements are presented in cm



# AG 3220 Vero Polo

220 g/m<sup>2</sup>  
 100% Cotton  
 Breathable fabric  
 Ribbed polo collar  
 3 dyed-to-match buttons  
 Short sleeves with ribbed armbands  
 Double-needle bottom hem  
 Clean finished placket  
 Side seams  
 Tear away Label  
 Sizes : S - 4XL  
 RRP : 49.90 MYR / 19.90 SGD



Size	S	M	L	XL	2XL	3XL	4XL
Chest	45	48	51	54	57	61	65
Length	63	66	69	72	75	77	79
Shoulder	41	44	47	50	53	57	61
Sleeve	19	19.5	20	20.5	21	22	22.5

Measurements may vary +/- 5% from actual product  
 Measurements are presented in cm



The collar is classic and three button placket.

Short sleeves with ribbed cuffs.

Double stitching on hem.

Chain stitching is neat.



Main Menu

# 858A0

## Gildan Hammer Cotton Pique Polo Shirt

220 g/m<sup>2</sup> (6.5 oz/yd<sup>2</sup>)  
100% ring spun cotton  
Soft, heavyweight fabric  
Contoured welt collar and cuffs  
3 dyed-to-match buttons  
Rolled forward topstitched shoulder  
Clean finished placket  
Modern Classic fit  
Side seams, Side vents  
Tear away label  
Sizes : S - 3XL  
RRP : 69.90 MYR / 27.90 SGD



Size	S	M	L	XL	2XL	3XL
Chest	46	49	52	55	59	62
Length	65	68	71	75	79	82
Shoulder	40	43	46	49	52	55
Sleeve	20	21	22	23	24	25

Measurements may vary +/- 5% from actual product  
Measurements are presented in cm



Main Menu



Simple and comfortable polo shirt. Balanced cut looks great tucked in or untucked. Versatile basic design and cut for easy styling. Collar looks great buttoned-up or undone.

Main Menu

NORTH HARBOUR®



Main Menu



# NHB 2400

## Soft-Touch Polo

60% Cotton 40% Polyester Lacoste  
 Ribbed polo collar  
 Three-button placket  
 Short sleeves with ribbed armbands  
 Double-needle bottom hem  
 Laser engraved buttons  
 Fiber content varies by color, see color list for details  
 Classic Fit  
 Woven Label  
 30 colors

Sizes : XS - 7XL  
 RRP : 49.90 MYR / 19.90 SGD

Size	XS	S	M	L	XL	2XL	3XL	4XL	5XL	6XL	7XL
Chest	18	19	20	21	22	23	24	25	26	27	28
Length	26	27	28	29	30	31	32	33	33	34	34
Shoulder	16	17	18	19	20	21	22	22	23	24	25
Sleeve	7	7.5	8	8.5	9	9.5	10	10.5	11	11.5	12

Measurements may vary +/- 5% from actual product  
 Measurements are presented in inches



NORTH HARBOUR®

# NHB 2100 Georgia Polo

65% Cotton 35% Polyester Lacoste  
 Ribbed polo collar  
 Pearlized buttons  
 Short sleeves with ribbed armbands  
 Double-needle bottom hem  
 Bold diagonal panel design  
 Woven label  
 Sizes : S - 3XL  
 RRP : 49.90 MYR / 19.90 SGD



**NHB 2101** Gold / Navy  
**NHB 2102** Red / White  
**NHB 2104** Navy / White



**NHB 2103** Charcoal / Royal  
**NHB 2105** Sport Grey / Black

Size	S	M	L	XL	2XL	3XL
Chest	19	20	21	22	23	24
Length	27	28	29	30	31	32
Shoulder	17	18	19	20	21	22
Sleeve	7.5	8	8.5	9	9.5	10

Measurements may vary +/- 5% from actual product  
 Measurements are presented in inches



NORTH HARBOUR®

# NHB 2200 York Polo

65% Cotton 35% Polyester Lacoste  
 Sleek tipping collar design  
 Front button closure  
 Pearlized buttons  
 Contrasting ribbed armbands  
 Mandarin collar  
 Double-needle bottom hem  
 Side vents at hem  
 Casual, meet smart  
 Regular fit  
 Woven Label  
 Sizes : S - 3XL  
 RRP : 49.90 MYR / 19.90 SGD



**NHB 2201** Black / Gold  
**NHB 2202** Red / Black



**NHB 2203** Navy / Red  
**NHB 2206** Sport Grey / Navy / Red



**NHB 2204** Charcoal / Royal  
**NHB 2205** Royal / Sapphire



Size	S	M	L	XL	2XL	3XL
Chest	19	20	21	22	23	24
Length	27	28	29	30	31	32
Shoulder	17	18	19	20	21	22
Sleeve	7.5	8	8.5	9	9.5	10

Measurements may vary +/- 5% from actual product  
 Measurements are presented in inches

Main Menu



NORTH HARBOUR®

## NHB 2300 Murphy Polo

65% Cotton 35% Polyester Lacoste  
Ribbed polo collar  
Pearlized buttons  
Bold color matching sleeve  
Short sleeves with ribbed armbands  
Double-needle bottom hem  
Side vents at hem  
Woven Label  
Sizes : S - 3XL  
RRP : 49.90 MYR / 19.90 SGD

Size	S	M	L	XL	2XL	3XL
Chest	19	20	21	22	23	24
Length	27	28	29	30	31	32
Shoulder	17	18	19	20	21	22
Sleeve	7.5	8	8.5	9	9.5	10

Measurements may vary +/- 5% from actual product  
Measurements are presented in inches



Main Menu

NORTH HARBOUR®

## NHB 2500 Muller Polo

65% Cotton 35% Polyester Lacoste  
Knitted tipping collar and placket  
Stripes on front placket  
Pearlized buttons  
Contrast color shoulder panel  
Double-needle sleeve and bottom hems  
Side vents at hem  
Woven Label  
Sizes : S - 3XL  
RRP : 49.90 MYR / 19.90 SGD



Size	S	M	L	XL	2XL	3XL
Chest	19	20	21	22	23	24
Length	27	28	29	30	31	32
Sleeve	12.5	13.5	14.5	15.5	16.5	17.5

Measurements may vary +/- 5% from actual product  
Measurements are presented in inches





Main Menu

NORTH HARBOUR®

65% Cotton 35% Polyester Lacoste  
 Knitted tipping collar & cuffs  
 Pearlized buttons  
 Double-needle bottom hem  
 Side vents at hem  
 Casual, meet smart  
 Woven Label  
 Sizes : S - 3XL  
 RRP : 49.90 MYR / 19.90 SGD

Size	S	M	L	XL	2XL	3XL
Chest	19	20	21	22	23	24
Length	27	28	29	30	31	32
Shoulder	17	18	19	20	21	22
Sleeve	7.5	8	8.5	9	9.5	10

Measurements may vary +/- 5% from actual product  
 Measurements are presented in inches

## NHB 2700 Saffron Polo



NORTH HARBOUR®

Main Menu

## NHB 3200 Mojo Polo

65% Cotton 35% Polyester Lacoste  
 Knitted tipping collar, cuffs & pocket  
 Pearlized buttons  
 Welt chest pocket  
 Double-needle bottom hem  
 Side vents at hem  
 Woven Label  
 Sizes : S - 3XL  
 RRP : 49.90 MYR / 19.90 SGD



Size	S	M	L	XL	2XL	3XL
Chest	19	20	21	22	23	24
Length	27	28	29	30	31	32
Shoulder	17	18	19	20	21	22
Sleeve	7.5	8	8.5	9	9.5	10

Measurements may vary +/- 5% from actual product  
 Measurements are presented in inches



## Main Menu

NORTH HARBOUR®

# NHB 3300 Collins Polo

65% Cotton 35% Polyester Lacoste  
 Ribbed polo collar  
 Half zip pullover  
 Contrast color shoulder panel design  
 Short sleeves with ribbed armbands  
 Double-needle bottom hem  
 Side vents at hem  
 Casual, meet smart  
 Woven Label  
 Sizes : S - 3XL  
 RRP : 49.90 MYR / 19.90 SGD



**NHB 3301**  
Black /  
Sapphire / Charcoal



**NHB 3302**  
White /  
Red / Navy



**NHB 3303**  
Red /  
Charcoal / White



**NHB 3304**  
Yellow /  
Forest Green / White

Size	S	M	L	XL	2XL	3XL
Chest	19	20	21	22	23	24
Length	27	28	29	30	31	32
Sleeve	12.5	13.5	14.5	15.5	16.5	17.5

Measurements may vary +/- 5% from actual product  
 Measurements are presented in inches



NORTH HARBOUR®

## Main Menu

# NHB 24400 Long Sleeve Soft-touch Polo

60% Cotton 40% Polyester Lacoste  
 Ribbed polo collar  
 Three-button placket  
 Long sleeves with ribbed cuffs  
 Double-needle bottom hem  
 Laser engraved buttons  
 Woven Label  
 Sizes : XS - 4XL  
 RRP : 49.90 MYR / 19.90 SGD



**NHB 24401**  
Black



**NHB 24402**  
White



**NHB 24418**  
Sport Grey



**NHB 24405**  
Navy



**NHB 24407**  
Forest Green



**NHB 24413**  
Red



**NHB 24414**  
Maroon

Size	XS	S	M	L	XL	2XL	3XL	4XL
Chest	18	19	20	21	22	23	24	25
Length	26	27	28	29	30	31	32	33
Shoulder	16	17	18	19	20	21	22	23
Sleeve	22	22.5	23	23.5	24	24.5	25	25.5

Measurements may vary +/- 5% from actual product  
 Measurements are presented in inches



Main Menu



Size	XS	S	M	L	XL	2XL	3XL	4XL	5XL	6XL	7XL
Chest	18	19	20	21	22	23	24	25	26	27	28
Length	26	27	28	29	30	31	32	33	34	35	36
Shoulder	15	16	17	18	19	20	21	22	23	24	25
Sleeve	7	7.5	8	8.5	9	9.5	10	10	10	10	10

Measurements may vary +/- 5% from actual product  
 Measurements are presented in inches

Main Menu



## CRP 8000

### DRYtec Performance Polo

150 g/m<sup>2</sup>  
 Pindot 75D/72F  
 DRYtec technology  
 Quick-dry, lightweight material  
 Polo neck, Solid-toned  
 Sideseamed

Double needle sleeve and bottom hems  
 Greater stretch and recovery  
 Soft feel, Antimicrobial, Anti-odor  
 Tear away label  
 10 colors available  
 Sizes : XS - 7XL  
 RRP : 34.90 MYR / 13.90 SGD

Main Menu

CROSSRUNNER®



Main Menu

# CRP 7200

## COLtec

### Performance Polo

160 g/m<sup>2</sup>  
 100% Performance Dry Pique  
 Moisture-wicking performance fabric  
 Polo neck, Solid-toned  
 Soft feel, Antimicrobial, Anti-odor  
 Greater stretch and recovery  
 Extra mobility & range of motion  
 Quick-dry, lightweight material  
 30 colors available  
 Tear away label  
 Sizes : XS - 7XL  
 RRP : 39.90 MYR / 16.90 SGD

Size	XS	S	M	L	XL	2XL	3XL	4XL	5XL	6XL	7XL
Chest	18	19	20	21	22	23	24	25	26	27	28
Length	26	27	28	29	30	31	32	33	34	35	36
Shoulder	15	16	17	18	19	20	21	22	23	24	25
Sleeve	7	7.5	8	8.5	9	9.5	10	10	10	10	10

Measurements may vary +/- 5% from actual product  
 Measurements are presented in inches



30  
COLORS





Main Menu



CROSSRUNNER®

# CRP 1300 Delta Polo Quick-drying

160 g/m<sup>2</sup>  
 100% Performance Dry Pique  
 Contrast color waist panel & piping design  
 Pearlized buttons  
 Antimicrobial, Anti-odor  
 Quick-dry, lightweight material  
 Extra mobility & range of motion  
 Greater stretch and recovery  
 Soft feel, breathable performance  
 Moisture-wicking performance fabric  
 Satin label  
 Sizes: S - 3XL  
 RRP : 49.90 MYR / 19.90 SGD

Size	S	M	L	XL	2XL	3XL
Chest	19	20	21	22	23	24
Length	27	28	29	30	31	32
Shoulder	17	18	19	20	21	22
Sleeve	7.5	8	8.5	9	9.5	10

Measurements may vary +/- 5% from actual product  
Measurements are presented in inches



# CRP 1600 Racer Polo Light & Stretchy

Main Menu

160 g/m<sup>2</sup>  
 100% Performance Dry Pique  
 Contrast color shoulder panel design  
 Pearlized buttons  
 Antimicrobial, Anti-odor  
 Quick-dry, lightweight material  
 Extra mobility & range of motion  
 Greater stretch and recovery  
 Soft feel, breathable performance  
 Moisture-wicking performance fabric  
 Satin label  
 Sizes: S - 3XL  
 RRP : 49.90 MYR / 19.90 SGD

Size	S	M	L	XL	2XL	3XL
Chest	19	20	21	22	23	24
Length	27	28	29	30	31	32
Shoulder	17	18	19	20	21	22
Sleeve	7.5	8	8.5	9	9.5	10

Measurements may vary +/- 5% from actual product  
Measurements are presented in inches



CROSSRUNNER®



Main Menu

# CRP 2300 Oxley Polo

160 g/m<sup>2</sup>  
 100% Performance Dry Pique  
 Classic elegant shoulder piping  
 Pearlized buttons  
 Antimicrobial, Anti-odor  
 Quick-dry, lightweight material  
 Extra mobility & range of motion  
 Greater stretch and recovery  
 Soft feel, breathable performance  
 Moisture-wicking performance fabric  
 Satin label  
 Sizes : S - 3XL  
 RRP : 49.90 MYR / 19.90 SGD



CROSSRUNNER®



Size	S	M	L	XL	2XL	3XL
Chest	19	20	21	22	23	24
Length	27	28	29	30	31	32
Shoulder	17	18	19	20	21	22
Sleeve	7.5	8	8.5	9	9.5	10

Measurements may vary +/- 5% from actual product  
 Measurements are presented in inches

CROSSRUNNER®

Main Menu

# CRP 2500 Ocean Polo Quick-drying

160 g/m<sup>2</sup>  
 100% Performance Dry Pique  
 Classic tapping shoulder design  
 Pearlized buttons  
 Antimicrobial, Anti-odor  
 Quick-dry, lightweight material  
 Extra mobility & range of motion  
 Greater stretch and recovery  
 Soft feel, breathable performance  
 Moisture-wicking performance fabric  
 Satin label  
 Sizes : S - 3XL  
 RRP : 49.90 MYR / 19.90 SGD

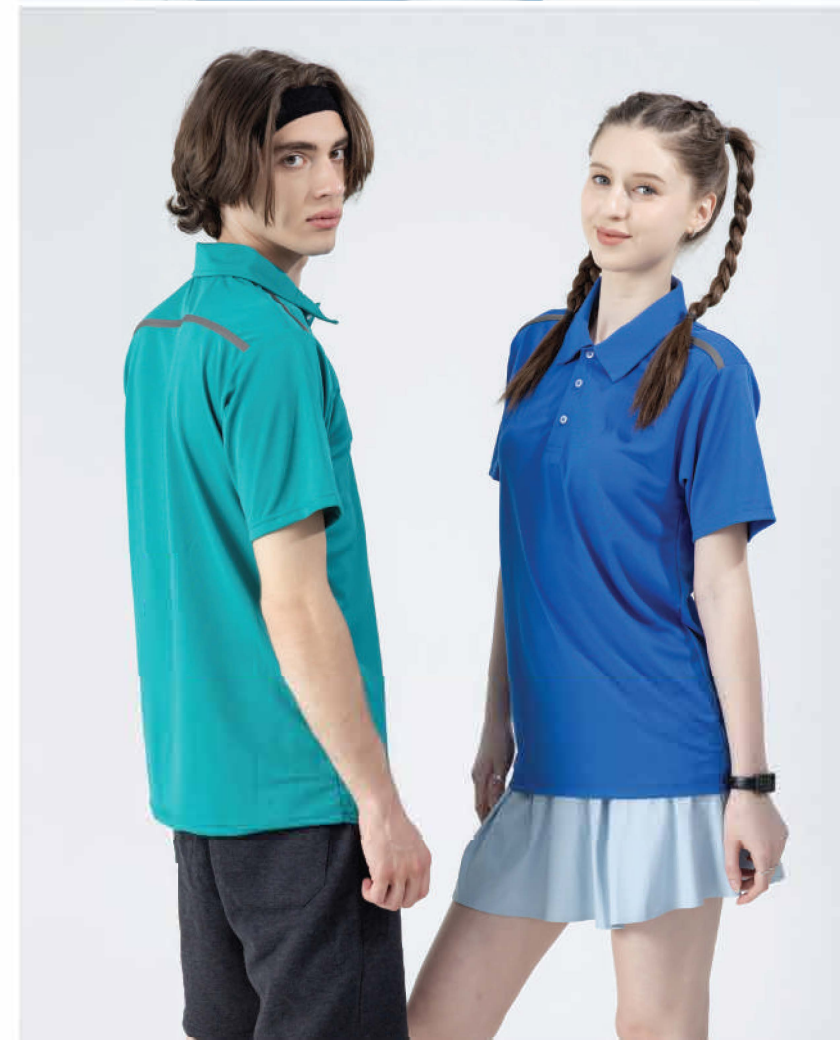

Size	S	M	L	XL	2XL	3XL
Chest	19	20	21	22	23	24
Length	27	28	29	30	31	32
Shoulder	17	18	19	20	21	22
Sleeve	7.5	8	8.5	9	9.5	10

Measurements may vary +/- 5% from actual product  
 Measurements are presented in inches

Main Menu

CROSSRUNNER®



ENGINEERED TO PERFORM

Main Menu

160 g/m<sup>2</sup>  
 100% Performance Jacquard Pique  
 Contrast piping design  
 Stand collar half zip pullover  
 Antimicrobial, Anti-odor  
 Quick-dry, lightweight material  
 Extra mobility & range of motion  
 Greater stretch and recovery  
 Soft hand feel, breathable performance  
 Moisture-wicking performance fabric  
 Satin label  
 Sizes : S - 3XL  
 RRP : 49.90 MYR / 19.90 SGD



**CRP 2901**  
Red / White



**CRP 2902**  
Sapphire / White



**CRP 2903**  
Navy / White



**CRP 2904**  
Black / White

Size	S	M	L	XL	2XL	3XL
Chest	19	20	21	22	23	24
Length	27	28	29	30	31	32
Shoulder	17	18	19	20	21	22
Sleeve	7.5	8	8.5	9	9.5	10

Measurements may vary +/- 5% from actual product  
 Measurements are presented in inches

**CRP 2900**  
Paragon Polo



CROSSRUNNER®

# CRP 3100 Harley Polo Light & Stretchy

160 g/m<sup>2</sup>  
 100% Performance Dry Pique  
 Contrast color lower chest panel design  
 Ribbed Polo collar  
 Pearlized buttons  
 Antimicrobial, Anti-odor  
 Short sleeves with ribbed armbands  
 Extra mobility & range of motion  
 Greater stretch and recovery  
 Soft feel, breathable performance  
 Moisture-wicking performance fabric  
 Satin label  
 Sizes : XS - 3XL  
 RRP : 49.90 MYR / 19.90 SGD



Size	XS	S	M	L	XL	2XL	3XL
Chest	18	19	20	21	22	23	24
Length	26	27	28	29	30	31	32
Shoulder	15.5	16.5	17.5	18.5	19.5	20.5	21.5
Sleeve	7	7.5	8	8.5	9	9.5	10

Measurements may vary +/- 5% from actual product  
 Measurements are presented in inches



CROSSRUNNER®



# CRP 3200 Dynamic Polo

160 g/m<sup>2</sup>  
 100% Performance Dry Pique  
 Knitted tipping collar & half zip pullover  
 Contrast color shoulder panel design  
 Special shape sliding design across sleeves  
 Quick-dry, lightweight material  
 Antimicrobial, Anti-odor  
 Soft feel, breathable performance  
 Moisture-wicking performance fabric  
 Satin label  
 Sizes : XS - 3XL  
 RRP : 49.90 MYR / 19.90 SGD



Size	XS	S	M	L	XL	2XL	3XL
Chest	18	19	20	21	22	23	24
Length	26	27	28	29	30	31	32
Sleeve	11.5	12.5	13.5	14.5	15.5	16.5	17.5

Measurements may vary +/- 5% from actual product  
 Measurements are presented in inches

Main Menu



## AIR SUPPLY ACTIVE TEE

keeps air flowing during your moves

## 20 COLORS



New Drytech Series  
from Crossrunner Comfort's calling!  
Ultra breathable. Super lightweight.  
Unique Stretch Sensation.

Main Menu



CROSSRUNNER®

## CRR 7000 DRYtec Performance Tee

130 g/m<sup>2</sup>- colour tee  
150 g/m<sup>2</sup>- white tee  
Pindot 75D/72F  
Anti UV 30+  
DRYtec technology  
Lightweight, Quick dry  
1.5 cm self fabric collar, Sideseamed  
Double needle sleeve and bottom hems  
Tear away label  
Sizes : XS - 7XL  
RRP : 25.90 MYR / 9.90 SGD

Size	XS	S	M	L	XL	2XL	3XL	4XL	5XL	6XL	7XL
Chest	17.5	18.5	20	21	22	23	24.5	25.5	27	28	29
Length	25.5	27	28	29	30	30.5	31.5	32	33	34	34.5
Shoulder	15	17	17.5	18	19.5	21.5	21.5	23.5	23.5	25.5	25.5
Sleeve	7.5	8	8	8.5	9	9	9.5	9.5	10	10	10

Measurements may vary +/- 5% from actual product  
Measurements are presented in inches



160 g/m<sup>2</sup>  
 100% Performance Dry Pique  
 Round neckline, Solid-toned tee  
 Moisture-wicking performance fabric  
 Antimicrobial, Anti-odor  
 Soft feel, breathable performance  
 Extra mobility & range of motion  
 Quick-dry, lightweight material  
 Tear away label  
 30 colors available  
 Sizes : XS - 7XL  
 RRP : 29.90 MYR / 11.90 SGD

# CRR 3600

## COLtec Performance Tee

Size	XS	S	M	L	XL	2XL	3XL	4XL	5XL	6XL	7XL
Chest	17.5	18.5	20	21	22	23	24.5	25.5	27	28	29
Length	25.5	27	28	29	30	30.5	31.5	32	33	34	34.5
Shoulder	15	17	17.5	18	19.5	21.5	21.5	23.5	23.5	25.5	25.5
Sleeve	7.5	8	8	8.5	9	9	9.5	9.5	10	10	10

Measurements may vary +/- 5% from actual product  
 Measurements are presented in inches

**30**  
COLORS





# CRR 3900

## Crossrunner Plus Performance Tee

160 g/m<sup>2</sup>  
 100% Performance Jacquard Pique  
 Round neckline, Solid-toned tee  
 Soft and smooth handfeel  
 Moisture-wicking performance fabric  
 Antimicrobial, Anti-odor  
 Greater stretch and recovery  
 Extra mobility & range of motion  
 Double-needle sleeve and bottom hems  
 Best for training & lifestyle  
 Quick-dry, breathable, lightweight material  
 Tagless heat transfer label  
 Sizes : XS - 3XL  
 RRP : 39.90 MYR / 16.90 SGD



Size	XS	S	M	L	XL	2XL	3XL
Chest	18	19	20	21	22	23	24
Length	26	27	28	29	30	31	32
Shoulder	16	17	18	19	20	21	22
Sleeve	7	7.5	8	8.5	9	9.5	10

Measurements may vary +/- 5% from actual product  
 Measurements are presented in inches



# CRR 1300 Zen Tee

## Quick-drying

160 g/m<sup>2</sup>  
 100% Performance Dry Pique  
 Contrast color panel design  
 Antimicrobial, Anti-odor  
 Quick-dry, lightweight material  
 Extra mobility & range of motion  
 Greater stretch and recovery  
 Soft feel, breathable performance  
 Moisture-wicking performance fabric  
 Best for training & lifestyle  
 Tagless heat transfer label  
 Sizes : S - 3XL  
 RRP : 39.90 MYR / 16.90 SGD



Size	S	M	L	XL	2XL	3XL
Chest	19	20	21	22	23	24
Length	27	28	29	30	31	32
Sleeve	12.5	13.5	14.5	15.5	16.5	17.5

Measurements may vary +/- 5% from actual product  
 Measurements are presented in inches

# CRV 1700 VIGOR VEST

160 g/m<sup>2</sup>  
 100% Performance Jacquard Pique  
 Round neckline, Solid-toned tank  
 Soft and smooth handfeel  
 Antimicrobial, Anti-odor  
 Moisture-wicking performance fabric  
 Antimicrobial, Anti-odor  
 Greater stretch and recovery  
 Extra mobility & range of motion  
 Double-needle bottom hems  
 Tagless heat transfer label  
 Sizes : S - 3XL  
 RRP : 35.90 MYR / 19.90 SGD



Size	S	M	L	XL	2XL	3XL
Chest	19	20	21	22	23	24
Length	27	28	29	30	31	32
Shoulder	15.5	16.5	17	18	19	19.5

Measurements may vary +/- 5% from actual product  
 Measurements are presented in inches



Main Menu



**CRR 70400**  
DRYtec Long Sleeve Tee

130 g/m<sup>2</sup>- colour tee  
150 g/m<sup>2</sup>- white tee  
Pindot 75D/72F  
Anti UV 30+  
DRYtec technology  
Lightweight, Quick dry  
1.5 cm self fabric collar

Rib cuffs, Sideseamed  
Double needle bottom hems  
15 colors  
Tear away label  
Sizes : XS - 7XL  
RRP : 29.90 MYR / 11.90 SGD



Size	XS	S	M	L	XL	2XL	3XL	4XL	5XL	6XL	7XL
Chest	17.5	18.5	20	21	22	23	24.5	25.5	27	28	29
Length	25.5	27	28	29	30	30.5	31.5	32	33	34	34.5
Shoulder	15	17	17.5	18	19.5	21.5	21.5	23.5	23.5	25.5	25.5
Sleeve	22.5	23	23.5	24	24.5	25	25.5	26	26.5	27	27.5

Measurements may vary +/- 5% from actual product  
Measurements are presented in inches

Main Menu



**CRR 36400**  
Performance Long Sleeve Tee

Size	XS	S	M	L	XL	2XL	3XL
Chest	18	19	20	21	22	23	24
Length	26	27	28	29	30	31	32
Shoulder	16	17	18	19	20	21	22
Sleeve	22	22.5	23	23.5	24	24.5	25

Measurements may vary +/- 5% from actual product  
Measurements are presented in inches

160 g/m<sup>2</sup>  
100% Performance Dry Pique  
Moisture-wicking performance fabric  
Round neckline, Solid-toned tee  
Antimicrobial, Anti-odor  
Greater stretch and recovery  
Extra mobility & range of motion  
Soft feel, breathable performance  
Quick-dry, lightweight material  
Tagless heat transfer label  
9 colors  
Sizes : XS - 3XL  
RRP : 32.90 MYR / 13.90 SGD





# CRR 7000B

## DRYtec Youth Tee

130 g/m<sup>2</sup> - colour tee  
 150 g/m<sup>2</sup> - white tee  
 Pindot 75D/72F  
 Anti UV 30+  
 DRYtec technology  
 Lightweight, Quick dry  
 Self fabric collar  
 Sideseamed  
 Double needle sleeve and bottom hems  
 15 colors available  
 Tear away label  
 Sizes : XS - 2XL  
 RRP : 20.90 MYR / 8.90 SGD



Size	XS	S	M	L	XL	2XL
Chest	13	14	15	16	17	18
Length	18	19	20	21	23	24
Shoulder	11	12	13	14	15	16
Sleeve	5	5.5	6	6.5	7	7.5

Measurements may vary +/- 5% from actual product  
 Measurements are presented in inches



Main Menu

# CRR 3600B Youth Performance Tee

Comfort & Quick dry

160 g/m<sup>2</sup>  
100% Performance Dry Pique  
Round neckline, Solid-toned tee  
Moisture-wicking performance fabric  
Antimicrobial, Anti-odor  
Soft feel, breathable performance  
Tear away label  
Sizes : YM - YL  
RRP : 29.90 MYR / 11.90 SGD

Size	YM	YL
Chest	14	15
Length	21	22
Shoulder	12	13
Sleeve	5.5	6

Measurements may vary +/- 5% from actual product  
Measurements are presented in inches



Main Menu

## 17 COLORS





Size	S	M	L	XL	2XL	3XL
Chest	60	62	64	66	68	70
Length	64	66	68	70	72	74
Shoulder	45	46	47.5	49	50	51.5
Sleeve	74.5	77	79.5	82	84.5	87

Measurements may vary +/- 5% from actual product  
Measurements are presented in cm

## NHJ 5100 City Line Jacket



749  
Mocha



036  
Black



032  
Navy

- High-performance outerwear
- Comfortable mesh interlining
- High neckline
- Hood rolls up inside the collar
- Elasticated cuffs
- Water-repellent finish
- Protects against light rain
- Front zip fastening
- 2 front side pockets
- 1 Inner Pocket
- Woven Label
- Sizes : S - 3XL
- RRP : 128.90 MYR / 49.90 SGD



**NHJ 1100  
BOMBER JACKET**

Solid tone bomber jacket  
Light weight polyester pongee  
Interlining with 210t polyester  
Wind resistant fabric  
Stand collar neckline

Elasticated cuffs and hem  
Long sleeve  
2 front side pockets  
1 inner pocket  
Front zip fastening

5 colors  
Woven Label  
Sizes : XS - 7XL  
RRP : 69.90 MYR / 27.90 SGD



Size	XS	S	M	L	XL	2XL	3XL	4XL	5XL	6XL	7XL
Width	20	21	21.5	22	23	24	25	25	26	27	28
Length	25.5	26	27	28	28.5	29.5	30	31	32	32.5	33
Shoulder	17	17.5	18	18.5	19	19.5	20	21	21.5	22	22.5
Sleeve	25	25.5	26	26.5	27	27.5	28	28.5	29	29.5	30

Measurements may vary +/- 5% from actual product  
Measurements are presented in inches



**NHJ 1101**  
Burgundy



**NHJ 1102**  
Light Grey



**NHJ 1103**  
Navy



**NHJ 1104**  
Black



**NHJ 1105**  
Army Green

**North Harbour**

Light and comfortable, versatile and contemporary design for any moment.  
If you are looking for a garment with its own personality, the bomber jacket is the right option  
to combine with your entire wardrobe in any of the colours we offer.



# 88000 Adult Crewneck Sweatshirt

285 g/m<sup>2</sup> (8.4 oz/yd<sup>2</sup>)  
 50% Cotton / 50% Polyester preshrunk fleece knit  
 2 x 1 rib with spandex  
 Sideseamed  
 Best for lifestyle  
 Regular fit  
 Authentic sweat fabric  
 Tear away label  
 Double-needle stitching at waistband and cuffs  
 Straight cut suits all body types  
 Versatile sweats for all outfits and occasions  
 Sizes : XS - 3XL  
 RRP : 79.90 MYR / 29.90 SGD



**30 N** White    **32 C** Navy    **40 C** Red    **95 H** Sport Grey    **36 C** Black

Size	XS	S	M	L	XL	2XL	3XL
Chest	19	20	21	22	24	25	26
Length	24	25	26	27	28	29	30
Shoulder	15.5	16.5	17.5	18.5	19.5	20.5	21.5
Sleeve	22	22.5	23	23.5	24	24.5	25

Measurements may vary +/- 5% from actual product  
 Measurements are presented in inches



OEKO-TEX®  
CONFIDENCE IN TEXTILES  
STANDARD 100  
68255 OeTI  
Tested for harmful substances  
www.oeko-tex.com/standard100



285 g/m<sup>2</sup> (8.4 oz/yd<sup>2</sup>)  
50% Cotton / 50% Polyester preshrunk fleece knit  
Double-needle stitching at waistband and cuffs  
Double-lined hood with color-matched drawcord  
2 x 1 rib with spandex  
Pouch pockets  
Sideseamed  
Best for lifestyle  
Tear away label  
Sizes : XS - 3XL  
RRP : 89.90 MYR / 32.90 SGD

# 88500

## Adult Hooded Sweatshirt



Size	XS	S	M	L	XL	2XL	3XL
Chest	19	20	21	22	24	25	26
Length	24	25	26	27	28	29	30
Shoulder	15.5	16.5	17.5	18.5	19.5	20.5	21.5
Sleeve	22	22.5	23	23.5	24	24.5	25

Measurements may vary +/- 5% from actual product  
Measurements are presented in inches

# 88600

## Adult Full Zip Hooded Sweatshirt

285 g/m<sup>2</sup> (8.4 oz/yd<sup>2</sup>)  
 50% cotton / 50% polyester preshrunk fleece knit  
 Double-needle stitching at waistband and cuffs  
 Unlined hood with color-matched drawcord  
 Metal Zipper  
 Pouch pockets  
 2 x 1 rib with spandex  
 Sideseamed  
 5 colors  
 Tear away label  
 Sizes : XS - 3XL  
 RRP : 89.90 MYR / 32.90 SGD

Size	XS	S	M	L	XL	2XL	3XL
Chest	19	20	21	22	24	25	26
Length	24	25	26	27	28	29	30
Shoulder	15.5	16.5	17.5	18.5	19.5	20.5	21.5
Sleeve	22	22.5	23	23.5	24	24.5	25

Measurements may vary +/- 5% from actual product  
 Measurements are presented in inches

**GILDAN**  
 Heavy Blend®

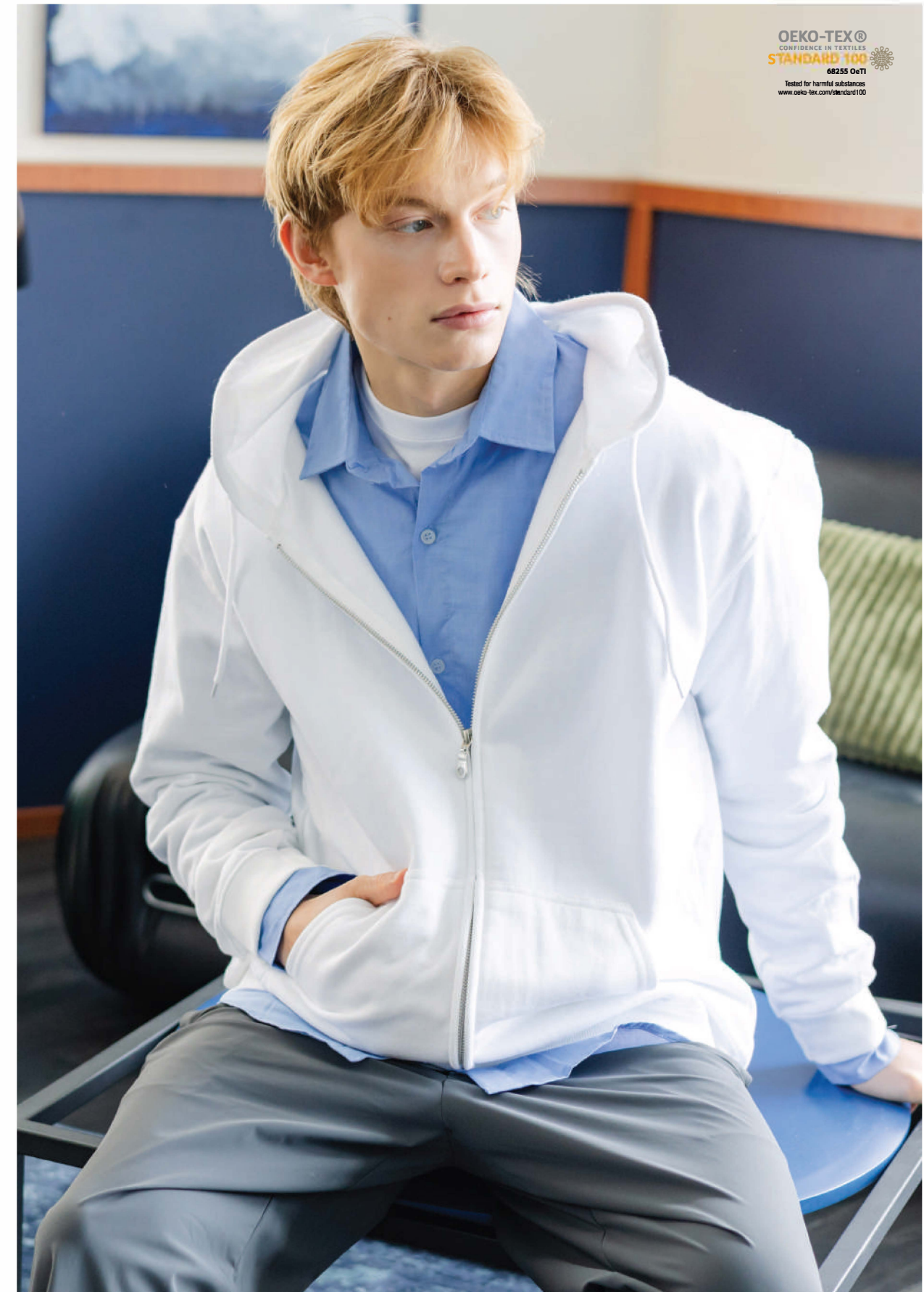

OEKO-TEX®  
 CONFIDENCE IN TEXTILES  
 STANDARD 100  
 66255 DhT  
 Tested for harmful substances  
 www.oeko-tex.com/standard100



**30 N**  
 White



**40 C**  
 Red



**32 C**  
 Navy



**95 H**  
 Sport Grey



**36 C**  
 Black

NORTH HARBOUR®

# NHOH 1100

## Harper Oversized Hoodie

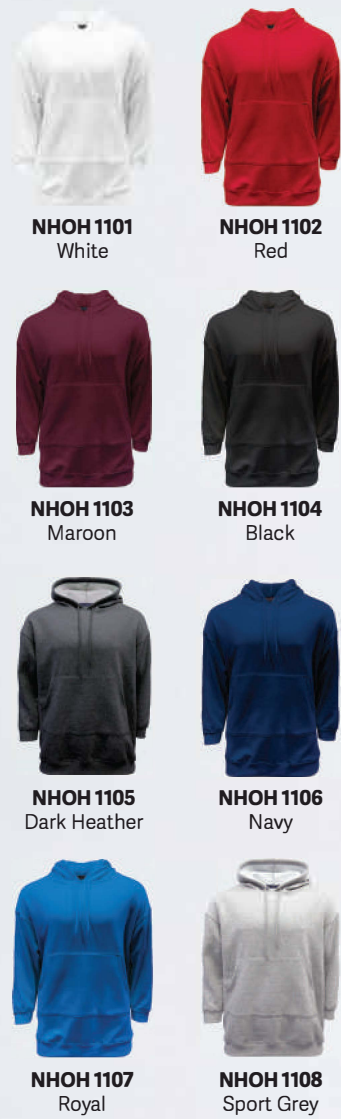

260 g/m<sup>2</sup> (7.67 oz/yd<sup>2</sup>)  
 60% Cotton 40% Polyester CVC Fleece  
 Ribbed cuffs and hem  
 Oversized fit  
 Hooded neckline  
 Color-matched drawcord  
 Kangaroo pocket

Soft and comfortable  
 Straight cut suits all body types  
 Best for lifestyle  
 Satin label  
 8 colors  
 Sizes : S - 2XL  
 RRP : 79.90 MYR / 32.90 SGD

Size	S	M	L	XL	2XL
Chest	23.5	24	25	26	26.5
Length	30	30.5	31.5	32	33
Shoulder	24	25	26	26.5	27
Sleeve	18	18.5	19	19.5	20

Measurements may vary +/- 5% from actual product  
 Measurements are presented in inches

# CRJ 3100

## Baseball Jacket

50% Cotton, 50% Polyester Polar Fleece  
 300 g/m<sup>2</sup> (8.85 oz/yd<sup>2</sup>)  
 Varsity style jacket with tipping detail  
 Short stand collar  
 Striped rib-knit cuffs & collar  
 Snap button  
 Slanted welt pockets  
 Straight cut suits all body types  
 Authentic sweat fabric  
 Tear away label  
 Sizes : S - 3XL  
 RRP : 69.90 MYR / 27.90 SGD

Size	S	M	L	XL	2XL	3XL
Chest	20	21	22	23	24	25
Length	26.5	27.5	28.5	29.5	30.5	31.5
Shoulder	18	19	20	21	22	23
Sleeve	23.5	24	24.5	25	25.5	26

Measurements may vary +/- 5% from actual product  
 Measurements are presented in inches



### 5 COLORS



CRJ 3101  
Red / White



CRJ 3102  
Black / White



CRJ 3103  
Forest Green / White



CRJ 3104  
Navy / White



CRJ 3105  
Sport Grey / White

# CRJ 1100B

## Youth Varsity Jacket

A fun take on the classic



Size	S	M	L	XL
Chest	14	15	16	17
Length	21	22	23	24
Shoulder	12	13	14	15
Sleeve	16	16.5	17	17.5

Measurements may vary +/- 5% from actual product  
Measurements are presented in inches

60% Cotton 40% Polyester CVC Fleece  
Varsity style jacket with tipping detail  
Striped rib-knit cuffs & collar  
Short stand collar  
Slanted welt pockets  
Straight cut suits all body types  
Authentic sweat fabric  
Satin label  
12 Colors  
Sizes : S - XL  
RRP : 59.90 MYR / 21.90 SGD



The perfect combination of stylish and practical, these classic retro youth varsity jackets are a must have.



- 

**CRJ 1101B**  
Red / White
- 

**CRJ 1102B**  
Black / White
- 

**CRJ 1103B**  
Royal / White
- 

**CRJ 1104B**  
Navy / White
- 

**CRJ 1105B**  
Sport Grey / White
- 

**CRJ 1106B**  
Maroon / White
- 

**CRJ 1107B**  
Black
- 

**CRJ 1108B**  
Navy
- 

**CRJ 1109B**  
Royal
- 

**CRJ 1110B**  
Red
- 

**CRJ 1111B**  
Maroon
- 

**CRJ 1112B**  
Sport Grey

# NHH 1100B

## Payton Hoodie - Youth

260 g/m<sup>2</sup> (7.67 oz/yd<sup>2</sup>)  
 60% Cotton 40% Polyester CVC Fleece  
 Ribbed cuffs and hem  
 Hooded neckline  
 Kangaroo pocket  
 Soft and comfortable  
 Satin label  
 8 Colors  
 Sizes : S - XL  
 RRP : 69.90 MYR / 27.90 SGD

Size	S	M	L	XL
Chest	14	15	16	17
Length	19	20	21	22
Shoulder	12	13	14	15
Sleeve	18	18.5	19	19.5

Measurements may vary +/- 5% from actual product  
 Measurements are presented in inches





NORTH HARBOUR®

## North Harbour KIDS

Exclusively designed by us for you. Keep the little ones comfy this season! Setting a sporty look this hooded sweater is constructed of premium fabric featuring a metal front zipper closure and functional side pockets! The cutest addition to your child's wardrobe.



**NHH 1201B**  
Navy

**NHH 1202B**  
Black

**NHH 1203B**  
White

**NHH 1204B**  
Dark Heather

**NHH 1205B**  
Red

**NHH 1206B**  
Royal

**NHH 1207B**  
Sport Grey

**NHH 1208B**  
Maroon



## NHH 1200B Rhodes Hoodie- Youth

260 g/m<sup>2</sup> (7.67 oz/yd<sup>2</sup>)  
60% Cotton 40% Polyester CVC Fleece  
Ribbed cuffs and hem  
Metal Zipper  
Hooded neckline  
Kangaroo pocket  
Soft and comfortable  
Satin Label  
Sizes : S - XL  
RRP : 69.90 MYR / 27.90 SGD

Size	S	M	L	XL
Chest	14	15	16	17
Length	19	20	21	22
Shoulder	12	13	14	15
Sleeve	18	18.5	19	19.5

Measurements may vary +/- 5% from actual product  
Measurements are presented in inches





# NHB 2000 Cotton Rayon Shirt

65% Cotton 35% Rayon  
 Pearlized buttons  
 Wrinkle-resistant even after washing for easy care  
 Smoother, more opaque material  
 Light and comfortable, high-quality fabric  
 Excellent breathability provides cool comfort  
 Button-through sleeve plackets  
 Meticulous attention to detail with a long hem  
 Rounded hemline  
 Woven Label  
 Sizes : S - 3XL  
 RRP : 79.90 / 31.90 SGD



**NHB 2001** Light Blue  
**NHB 2002** Gravel  
**NHB 2003** Carolina Blue

Size	S	M	L	XL	2XL	3XL
Chest	19.5	20.5	21.5	22.5	23.5	24.5
Length	28	29	30	31	32	33
Shoulder	17	18	19	20	21	22
Sleeve	23.5	24	24.5	25	25.5	26

Measurements may vary +/- 5% from actual product  
 Measurements are presented in inches



Main Menu



# NHB 1400 Premium Oxford

100% Premium Cotton Oxford  
 More opaque material, high-quality fabric  
 Pearlized buttons  
 Button-through sleeve plackets  
 Meticulous attention to detail with a long hem  
 Rounded hemline  
 Woven Label  
 Sizes : S - 3XL  
 RRP : 79.90 MYR / 31.90 SGD

## 3 COLORS



**NHB 1401** Black  
**NHB 1402** White  
**NHB 1403** Charcoal

Size	S	M	L	XL	2XL	3XL
Chest	19.5	20.5	21.5	22.5	23.5	24.5
Length	28	29	30	31	32	33
Shoulder	17	18	19	20	21	22
Sleeve	23.5	24	24.5	25	25.5	26

Measurements may vary +/- 5% from actual product  
 Measurements are presented in inches

NORTH HARBOUR®



NORTH HARBOUR®



100% Premium Cotton Oxford  
 More opaque material, high-quality fabric  
 Regular collar completes the look  
 Pearlized buttons  
 Great for both casual and dressier looks  
 Meticulous attention to detail with a long hem  
 Rounded hemline  
 Woven Label  
 Superior Retail Fit :  
 Sizes : S - 3XL  
 RRP : 79.90 MYR / 31.90 SGD

Main Menu



# NHB 1500 Premium Oxford Short Sleeve



**NHB 1501** Black  
**NHB 1502** White  
**NHB 1503** Charcoal

Size	S	M	L	XL	2XL	3XL
Chest	19.5	20.5	21.5	22.5	23.5	24.5
Length	28	29	30	31	32	33
Shoulder	17	18	19	20	21	22
Sleeve	8.5	9	9.5	10	10.5	11

Measurements may vary +/- 5% from actual product  
 Measurements are presented in inches



65% Viscose 35% Polyester  
 Pearlized buttons  
 Collar neckline  
 Front buttons fastening  
 Pocket on the chest  
 Contrast color design collar & sleeve  
 Back pleat detail  
 Rounded hemline  
 Regular fit  
 Woven Label  
 Sizes : S - 3XL  
 RRP : 69.90 MYR / 27.90 SGD

Size	S	M	L	XL	2XL	3XL
Chest	20	21	22	23	24	25
Length	30	31	32	32.5	33	33.5
Shoulder	17	18	19	20	21	22
Sleeve	8.5	9	9.5	10	10.5	11

Measurements may vary +/- 5% from actual product  
 Measurements are presented in inches

## NHB 1900 Smart Racewear



**NHB 1901**  
White / Navy



**NHB 1902**  
Sapphire / White



**NHB 1903**  
Red / Black



**NHB 1904**  
Charcoal / White

# NHB 3000 CYRIL SHIRT



65% Viscose 35% Polyester  
 Knitted tipping collar & cuffs  
 Pearlized buttons  
 Front buttons fastening  
 Great for both casual and dressier looks  
 Meticulous attention to detail with a long hem  
 Rounded hemline  
 Regular fit  
 Woven Label  
 Sizes : S - 3XL  
 RRP : 69.90 MYR / 27.90 SGD

Size	S	M	L	XL	2XL	3XL
Chest	20	21	22	23	24	25
Length	30	31	32	32.5	33	33.5
Shoulder	17	18	19	20	21	22
Sleeve	8.5	9	9.5	10	10.5	11

Measurements may vary +/- 5% from actual product  
 Measurements are presented in inches



**NHB 3001**  
White / Red / Black



**NHB 3002**  
Red / White / Navy



**NHB 3003**  
Navy / White / Red



**NHB 3004**  
Black / White / Red



# NHB 3400 Charms Shirt

## Short Sleeve

65% Cotton 35% Rayon  
 Mandarin Collar  
 Stand collared neckline  
 Pearlized buttons  
 Wrinkle-resistant even after washing for easy care  
 Smoother, more opaque material  
 Light and comfortable, high-quality fabric  
 Excellent breathability provides cool comfort  
 Rounded hemline  
 Woven Label  
 Sizes : S - 3XL  
 RRP : 69.90 MYR / 27.90 SGD

Size	S	M	L	XL	2XL	3XL
Chest	20	21	22	23	24	25
Length	30	31	32	32.5	33	33.5
Shoulder	17	18	19	20	21	22
Sleeve	8.5	9	9.5	10	10.5	11

Measurements may vary +/- 5% from actual product  
 Measurements are presented in inches



**NHB 3401** Black  
**NHB 3402** Fortune Red  
**NHB 3403** Emerald Green  
**NHB 3404** Olive Green



# SMW 1500 AMMARA

## Muslimah Wear Collection

40% Cotton 60% Polyester  
 Sporty Raglan design  
 Round neckline  
 Waistline pocket feature  
 A shape muslimah cutting  
 Woven label  
 Superior Retail Fit :  
 Ladies fitting from S to 3XL  
 RRP : 59.90 MYR / 23.90 SGD

Size	S	M	L	XL	2XL	3XL
Chest	19	20	21	22	23	24
Length	35	36	37	38	39	40
Sleeve	24	25	26	27	28	29

Measurements may vary +/- 5% from actual product  
 Measurements are presented in inches



**SMW 1501** Black / Royal  
**SMW 1502** Maroon / Charcoal  
**SMW 1503** Navy / Red  
**SMW 1504** Navy / Sapphire  
**SMW 1505** Black / Charcoal  
**SMW 1506** Maroon / Heliconia  
**SMW 1507** Forest Green / Lime

SARRA®

**SMW 1800**  
**OBADIAH**  
Muslimah Wear



**SMW 1801**  
Heliconia

**SMW 1802**  
Irish Green



**SMW 1803**  
Purple

**SMW 1804**  
Black



**SMW 1805**  
Navy

100% Performance Dry Pique  
Solid coloured muslimah top  
Round neckline  
Hidden side pocket  
New asian A shape muslimah cutting  
Lightweight material  
Soft feel, breathable performance  
Woven label  
Superior Retail Fit : S - 3XL  
RRP : 49.90 MYR / 19.90 SGD

Size	S	M	L	XL	2XL	3XL
Chest	19	20	21	22	23	24
Length	35	36	37	38	39	40
Shoulder	15.5	16.5	17.5	18.5	19.5	20.5
Sleeve	20.5	21	21.5	22	22.5	23

Measurements may vary +/- 5% from actual product  
Measurements are presented in inches





## CRSV 1100 Reflective Safety Vest - High Visibility

100% Polyester fabric mesh  
Weight : 120gsm  
Zip front closure  
Sewn on reflective tape

Reflective band in front and back  
5cm wide reflective tape  
Black bidding to garment edges  
Lightweight and durable

Quick drying fabric  
Excellent in warm weather  
RRP : 18.90 MYR / 7.50 SGD

Be seen be safe, with CRSV reflective safety vest. Ensure your employees are seen in warehouses and construction sites.



**CRSV 1101**  
Neon Green



**CRSV 1102**  
Neon Orange

Size	Width	Length	Shoulder
Free Size	60	70	46

Measurements may vary +/- 5% from actual product  
Measurements are presented in cm



# CRSV 2100 Reflective Safety Vest - Diamond



100% Polyester fabric mesh  
Weight : 120gsm  
Zip front closure  
Sewn on reflective tape  
Reflective band in front and back  
Micro Prismatic PVC Reflective Strap  
5cm wide diamond reflective tape  
Black bidding to garment edges  
High Visibility  
Lightweight and durable  
Quick-drying fabric  
Excellent in warm weather  
RRP : 19.90 MYR / 7.90 SGD



**CRSV 2101**  
Neon Green

Size	Width	Length	Shoulder
Free Size	60	65	46

Measurements may vary +/- 5% from actual product  
Measurements are presented in cm



# CRSV 3100 Reflective Safety Vest With Pocket

100% Polyester fabric mesh  
Weight : 120gsm  
Zip front closure  
3 Multi-function front pockets  
1 PVC transparent ID pocket  
1 Pen pocket  
Reflective band in front and back  
5cm wide reflective tape  
Black bidding to garment edges  
High Visibility, Quick-drying fabric  
Lightweight and durable  
Excellent in warm weather  
RRP : 22 .90 MYR / 8.90 SGD



**CRSV 3101**  
Neon Green

Size	Width	Length	Shoulder
Free Size	60	70	45

Measurements may vary +/- 5% from actual product  
Measurements are presented in cm



NORTH HARBOUR®

# NHA 1100 VICIOUS APRON



NHA 1101  
Black

NHA 1102  
Navy



NHA 1103  
Red

NHA 1104  
Royal



NHA 1105  
Forest Green

NHA 1106  
Khaki



Material : 100% Polyester  
With practical pockets for small items  
The loop makes it easy to hang  
Strong seams for extra durability  
Simplicity and elegance  
High-grade materials & excellent workmanship  
Available in 6 colors  
Easy care, machine washable  
Satin Label  
Size : 23.7" x 27.5"  
RRP : 29.90 MYR / 9.90 SGD

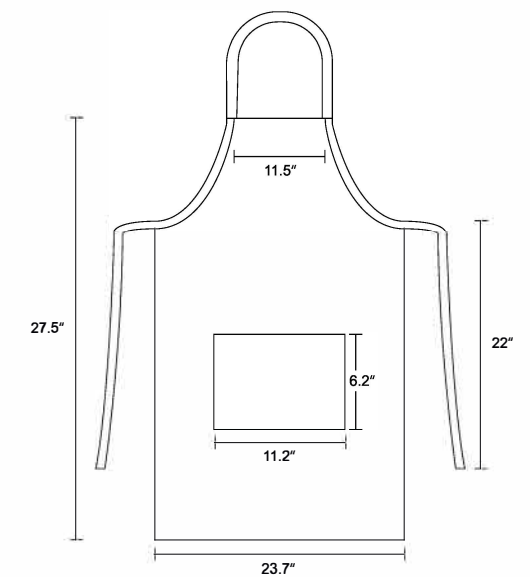

# NHC 1100 BASEBALL CAP

Acrylic twill  
 Six panel construction  
 6 breathable eyelets  
 6 rows of stitching on visor  
 Seamed front panel with full buckram  
 Curved peak  
 Pro stitch on crown  
 Matching fabric undervisor  
 Matching color sweatband  
 Metal sliding buckle closure  
 RRP : 26.90 MYR / 10.90 SGD

NORTH HARBOUR®



The classic baseball cap has become an indispensable beacon that calls out to like-minded individuals, whether it's embroidered with a sports team, college, or company logo. A trusty cap is a practical shade in the summer, but it can also signal a hobby or alignment.



## 16 COLORS



- |   |  |
|---|--|
| <br><b>NHC 1116</b><br>Dark Grey     | <br><b>NHC 1115</b><br>Gold       |
| <br><b>NHC 1113</b><br>Light Pink    | <br><b>NHC 1114</b><br>Sand       |
| <br><b>NHC 1104</b><br>Daisy         | <br><b>NHC 1111</b><br>Orange     |
| <br><b>NHC 1106</b><br>Red           | <br><b>NHC 1107</b><br>Maroon     |
| <br><b>NHC 1105</b><br>Forest Green | <br><b>NHC 1103</b><br>Black     |
| <br><b>NHC 1101</b><br>White       | <br><b>NHC 1102</b><br>Grey     |
| <br><b>NHC 1110</b><br>Charcoal    | <br><b>NHC 1112</b><br>Sapphire |
| <br><b>NHC 1108</b><br>Royal       | <br><b>NHC 1109</b><br>Navy     |



# KIND OF COOL TREND

Acrylic Twill  
 6-panel Fitted Cap  
 Seamed Front Panel with Full Buckram  
 6 Sewn Eyelets  
 Pro Stitch on Crown  
 6 Rows of Stitching on Visor  
 Matching Fabric Undervisor  
 Matching Color Sweatband  
 Adjustable Snap Closure  
 RRP : 29.90 MYR / 11.90 SGD



## NHC 1200 - SNAPBACK







- |   |   |  |   |
|---|---|--|---|
| <br><b>NHC 1203</b><br>Black | <br><b>NHC 1201</b><br>White | <br><b>NHC 1202</b><br>Grey         | <br><b>NHC 1205</b><br>Red |
| <br><b>NHC 1206</b><br>Royal | <br><b>NHC 1207</b><br>Navy  | <br><b>NHC 1204</b><br>Forest Green |   |



# NHT 1100 Soft Touch Hand Towel

Material: 100% Cotton  
 Weight: 80 gsm  
 Soft Touch hand feel  
 Ideal for a wide variety of uses  
 Striped border offers a touch of appeal  
 Exceptionally plush, rich and long lasting  
 Cozy comfort, durable and highly absorbent  
 Simplicity and elegance  
 Available in 7 colors  
 Easy care, machine washable  
 Woven label  
 Size: 32cm x 70cm  
 RRP : 29.90 MYR / 11.90 SGD



- |   |                               |   |                                |
|---|-------------------------------|---|--------------------------------|
|  | <b>NHT 1101</b><br>Soft White |  | <b>NHT 1105</b><br>Watermelon  |
|  | <b>NHT 1102</b><br>Corn Silk  |  | <b>NHT 1106</b><br>Light Brown |
|  | <b>NHT 1103</b><br>Mint Cream |  | <b>NHT 1107</b><br>Light Grey  |
|  | <b>NHT 1104</b><br>Dust Blue  |   |                                |





# NHT 2100 Soft Touch Spa Towel



Material: 100% Cotton  
 Weight: 400 gsm  
 Soft Touch hand feel  
 Ideal for washroom ensemble  
 Striped border offers a touch of appeal  
 Exceptionally plush, rich and long lasting  
 Cozy comfort, durable and highly absorbent  
 Simplicity and elegance  
 Available in 7 colors  
 Easy care, machine washable  
 Woven label  
 Size: 70cm x 140cm  
 RRP : 49.90 MYR / 19.90 SGD

- |   |   |   |   |
|---|---|---|---|
|  |  |  |  |
| <b>NHT 2101</b><br>Soft White   | <b>NHT 2102</b><br>Corn Silk  | <b>NHT 2103</b><br>Mint Cream   | <b>NHT 2104</b><br>Dust Blue  |
|  |  |  |   |
| <b>NHT 2105</b><br>Watermelon   | <b>NHT 2106</b><br>Light Brown  | <b>NHT 2107</b><br>Light Grey   |   |



# CRST 1100 Sports Towel

## Quick Dry

Material: Superfine fiber  
 Weight: 40 gsm  
 Highly absorbent  
 Anti-bacterial  
 Prevent Odour  
 Lightweight and soft  
 Compact design, Easy to pack  
 Fast-drying microfiber  
 Convenient and comfortable  
 Tear away label  
 Size: 13.7" x 25.5"  
 RRP : 22.90 MYR / 8.90 SGD



-  **CRST 1132**  
Baby Pink
-  **CRST 1131**  
Mint
-  **CRST 1108**  
Midnight
-  **CRST 1102**  
White



\*Please note that CRST 1102 white towel are friendly for sublimation printing, kindly contact CS for further information.



CRST 2132  
Baby Pink

CRST 2131  
Mint

CRST 2108  
Midnight

CRST 2102  
White

**CROSSRUNNER®**



## CRST 2100 Quick Dry Bath Towel

Material: Superfine fiber  
 Weight: 220 gsm  
 Highly absorbent  
 Anti-bacterial  
 Prevent Odour  
 Lightweight and soft  
 Compact design, Easy to pack  
 Fast-drying microfiber  
 Convenient and comfortable  
 Tear away label  
 Size: 29.5" x 55"  
 RRP : 32.90 MYR / 9.90 SGD

\*Please note that CRST 2102 white towel are friendly for sublimation printing, kindly contact CS for further information.

# NHTB 1100 Emrys Canvas Tote Bag

Material : 100% Fully cotton  
 Thickness : 10 oz  
 Bottomless  
 Eco organic material  
 High-grade materials  
 Excellent workmanship  
 Simplicity and elegance  
 Strong seams for extra durability  
 Tear away label  
 Size : 14"(w) x 15"(h)  
 RRP : 19.90 MYR / 7.90 SGD

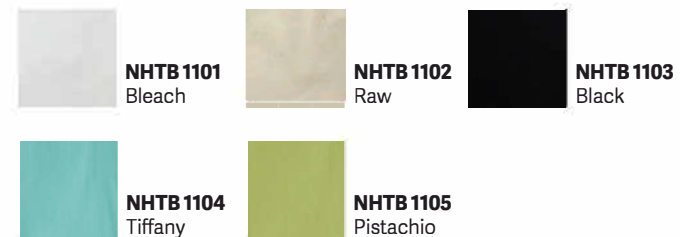







# NHTB 2100 Emrys Canvas Tote Bag

Material : 100% Fully cotton  
 Thickness : 10 oz  
 Eco organic material  
 Self Fabric handles  
 High-grade materials  
 Excellent workmanship  
 Simplicity and elegance  
 Strong seams for extra durability  
 Perfect size for daily use  
 Tear away label  
 Size : 18"(w) x 16"(h) x 5.5" (gusset)  
 RRP : 22.90 MYR / 8.90 SGD



-  **NHTB 2101**  
Bleach
-  **NHTB 2102**  
Raw
-  **NHTB 2103**  
Black
-  **NHTB 2104**  
Tiffany
-  **NHTB 2105**  
Pistachio

## Main Menu



210 g/m<sup>2</sup> (6.1 oz/yd<sup>2</sup>)  
 100% ring spun cotton  
 Soft washed garment dyed fabric  
 Double needle collar  
 Twill taped neck and shoulders  
 Twill label / Joker label  
 Double needle armhole  
 sleeve and bottom hems  
 Sizes : S - XL  
 RRP : 72.90 MYR / 28.90 SGD

Size	S	M	L	XL
Chest	18	20	22	24
Length	26.5	28	30	31.5
Shoulder	17	18.5	20.5	22
Sleeve	6.5	7	7.5	8

Measurements may vary +/- 5% from actual product  
 Measurements are presented in inches

## **BEST BUY** 1717 Adult T-Shirt



## Main Menu

**BEST BUY**

## Adult Midweight Camouflage Tee - 939

170 g/m<sup>2</sup> (4.9 oz/yd<sup>2</sup>)  
 Preshrunk jersey knit  
 100% Cotton, Ring Spun  
 Fabric 26/1  
 Classic Fit  
 Side seam construction  
 Shoulder-to-shoulder tape and seamed collar  
 Twin-needle neck, sleeve and bottom hem  
 Oeko-Tex® Standard 100 Certified  
 Tear away label  
 Sizes : S - 2XL  
 RRP : 39.90 MYR / 16.90 SGD



Size	S	M	L	XL	2XL
Chest	18	20	22	24	26
Length	28	29	30	31	32
Shoulder	16	18	20	22	24
Sleeve	7.5	8	8.5	9	9.5

Measurements may vary +/- 5% from actual product  
 Measurements are presented in inches

**ANVIL**  
 BY GILDAN



Camouflage or military print is one such print that is always in trend. From the newest looks to fresh takes on classic styles, ANVIL have all the bases covered. It fuses the mystery and abstraction into style and fashion.



**PANBASIC**

**P-901** **BEST BUY**  
**Adult Round Neck T-Shirt**

Weight: 160 Grams  
 Material : 100% Premium Cotton  
 100% ring-spun cotton preshrunk jersey knit  
 1.3 cm rib collar  
 Tape neck and shoulders  
 Double-needle sleeve and bottom hems  
 Adult Unisex  
 13 colors  
 Fabric : Jersey Knit  
 Size : XS – 7XL  
 RRP : 24.90 MYR / 10.90 SGD



Size	XS	S	M	L	XL	2XL	3XL	5XL	7XL
Chest	18	19	20	21	22	23	24	26	28
Length	25	26	27	28	29	30	31	34	36
Shoulder	16	17	18	19	20	21	22	24	25
Sleeve	7.5	8	8.5	9	9.5	10	10.5	11.5	11.5

Measurements may vary +/- 5% from actual product  
 Measurements are presented in cm

Lightweight and breathable T-shirt that will keep you feeling cool and comfortable all day. Perfect for the summer and hot weather. 100% cotton fabrics provide a soft, natural fabric that is fully breathable.



Made with high-quality, lightweight, quick-drying microfiber fabric, these shirts are suitable for casual hangouts with friends or as sports jerseys for athletic events.

100% Microfiber Jersey  
 Adult Unisex  
 Fiber content varies by color  
 Quick-dry, lightweight material  
 Double-needle sleeve and bottom hems  
 Material: 100% Microfiber  
 Fabric: Microfiber Mini Mesh  
 9 colors  
 Weight: 150 grams  
 Size: XS – 7XL  
 RRP : 34.90 MYR / 15.90 SGD



**PANBASIC**  
**BEST BUY** **P - 703**  
**AIRtec Quick Dry Polo - Microfiber Mini Mesh**

Size	XS	S	M	L	XL	2XL	3XL	5XL	7XL
Chest	18	19	20	21	22	23	24	26	28
Length	25	26	27	28	29	30	31	34	36
Shoulder	16	17	18	19	20	21	22	24	25
Sleeve	7.5	8	8.5	9	9.5	10	10.5	11.5	11.5

Measurements may vary +/- 5% from actual product  
 Measurements are presented in inches

Main Menu

**PANBASIC**

**P - 903** **BEST BUY**  
**AIRtec Quick Dry**  
**- Microfiber Mini Mesh**

100% Microfiber Jersey  
 Lightweight, breathable, and quick-dry  
 Double-needle sleeve and bottom hems  
 Fiber content varies by color  
 Weight: 150 grams  
 Adult Unisex  
 20 colors  
 Size: XS - 7XL  
 RRP : 24.90 MYR / 10.90 SGD

Size	XS	S	M	L	XL	2XL	3XL	5XL	7XL
Chest	18	19	20	21	22	23	24	26	28
Length	25	26	27	28	29	30	31	34	36
Shoulder	16	17	18	19	20	21	22	24	25
Sleeve	7.5	8	8.5	9	9.5	10	10.5	11.5	11.5

Measurements may vary +/- 5% from actual product  
 Measurements are presented in inches



Main Menu

**BEST BUY**

**CRP 1500**  
**Finisher Polo**

160 g/m<sup>2</sup>  
 100% Performance Dry Pique  
 Contrast color piping design  
 Pearlized buttons  
 Antimicrobial, Anti-odor  
 Quick-dry, lightweight material  
 Extra mobility & range of motion  
 Greater stretch and recovery  
 Soft feel, breathable performance  
 Moisture-wicking performance fabric  
 Best for training & lifestyle  
 Satin label  
 Sizes : S - 3XL  
 RRP : 49.90 MYR / 19.90 SGD



Size	S	M	L	XL	2XL	3XL
Chest	19	20	21	22	23	24
Length	27	28	29	30	31	32
Shoulder	17	18	19	20	21	22
Sleeve	7.5	8	8.5	9	9.5	10

Measurements may vary +/- 5% from actual product  
 Measurements are presented in inches

Main Menu



# CRR 1100

## Storm Tee

160 g/m<sup>2</sup>  
 100% Performance Dry Pique  
 Contrast color panel & stitching  
 Best for training & lifestyle  
 Antimicrobial, Anti-odor  
 Quick-dry, lightweight material  
 Extra mobility & range of motion  
 Soft feel, breathable performance  
 Moisture-wicking performance fabric  
 Tagless heat transfer label  
 Sizes : S - 3XL  
 RRP : 39.90 MYR / 16.90 SGD



Size	S	M	L	XL	2XL	3XL
Chest	19	20	21	22	23	24
Length	27	28	29	30	31	32
Sleeve	12.5	13.5	14.5	15.5	16.5	17.5

Measurements may vary +/- 5% from actual product  
 Measurements are presented in inches



Main Menu

# NHB 1700

## Synergy Racewear



### Premium Workwear

65% Viscose 35% Polyester  
 Pearlized buttons  
 Front button placket  
 Pocket on the chest  
 Contrast piping design  
 Meticulous attention to detail with a long hem  
 Rounded hemline  
 Woven Label  
 Superior Retail Fit :  
 Sizes : S - 3XL  
 RRP : 69.90 MYR / 27.90 SGD



Size	S	M	L	XL	2XL	3XL
Width	20	21	22	23	24	25
Length	30	31	32	32.5	33	33.5
Shoulder	17	18	19	20	21	22
Sleeve	8.5	9	9.5	10	10.5	11

Measurements may vary +/- 5% from actual product  
 Measurements are presented in inches



# Professional Custom Uniform Service

We specialize in providing one-stop uniform customization solutions, combining high-quality fabrics, diverse styles, and advanced printing techniques to meet the needs of businesses, schools, organizations, and events.

Printing Options:

- Embroidery
- Silkscreen Printing
- Heat Transfer / DTF (Direct to Film)
- DTG (Direct to Garment)
- Vinyl Heat Press
- Sublimation

Available Products:

- T-shirts, Polo shirts, Long sleeves
- Workwear, Corporate uniforms
- F&B uniforms, Aprons
- Jackets, Windbreakers, Baseball jackets
- Safety vests, F1-style uniforms
- Hats, Eco-friendly tote bags & accessories



Corporate Events | Staff Uniforms | Brand Promotions | School/Club Outfits  
Trade Shows | Charity Campaigns

# Sublimation Trend

The finish is smooth, soft, and stylish because it literally becomes one with the substrate.



Dye sublimation is an awesome printing technique that allows for vibrant, full color, all-over print for t-shirts and garments.

## No Designs Limit



DIRECT TO GARMENT

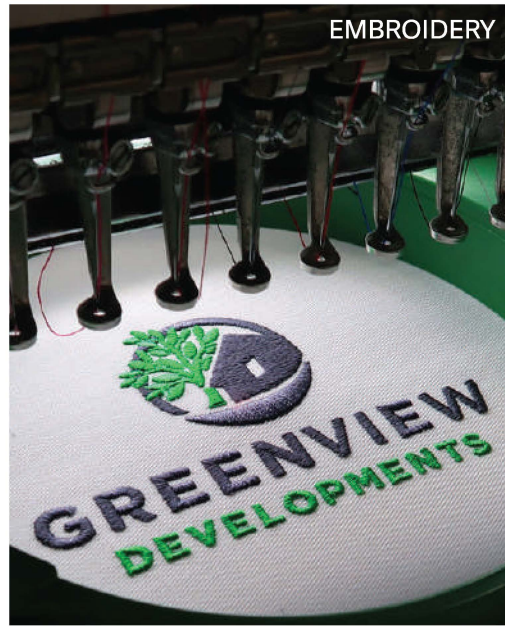

EMBROIDERY

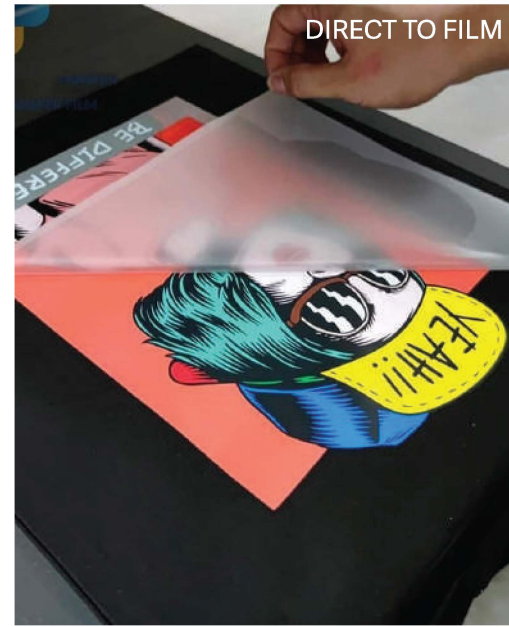

DIRECT TO FILM



HEAT TRANSFER

## Decorating Techniques



REFLECTIVE PRINTING



REFLECTIVE PRINTING



GLOW IN THE DARK



PUFF PRINT LETTERING

## Main Menu

### ACTIVEWEAR

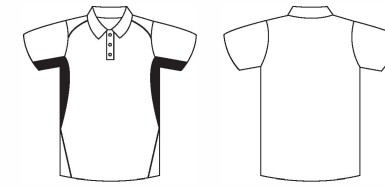

CRP 1300 - Delta Polo

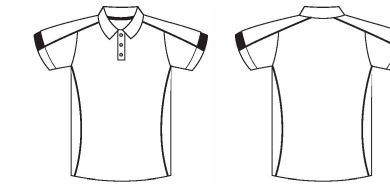

CRP 1500 - Finisher Polo

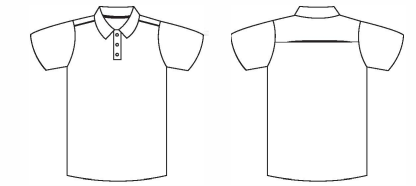

CRP 2300 - Oxley Polo

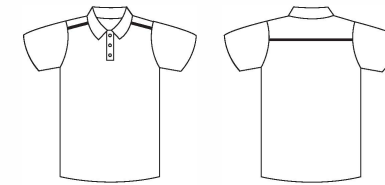

CRP 2500 - Ocean Polo



CRP 2900 - Paragon Polo

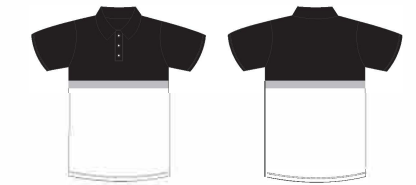

CRP 3100 - Harley Polo



CRP 3200 - Dyanamic Polo

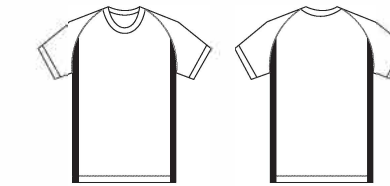

CRR 1100 - Storm Tee

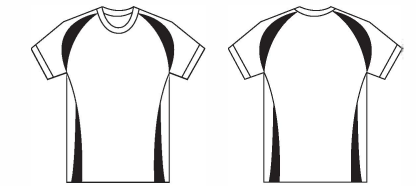

CRR 1300 - Zen Tee

### PREMIUM WORKWEAR

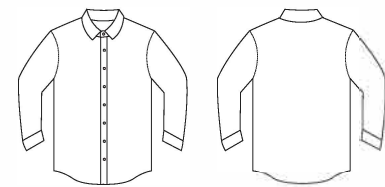

NHB 1400 - Premium Oxford

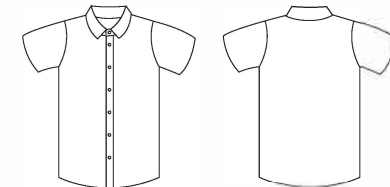

NHB 1500 - Oxford Short Sleeve

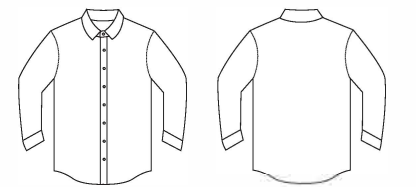

NHB 2000 - Cotton Rayon Shirt

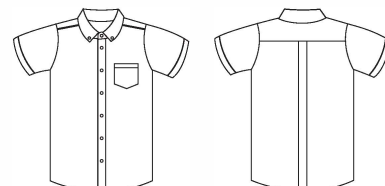

NHB 1700 - Synergy Racewear

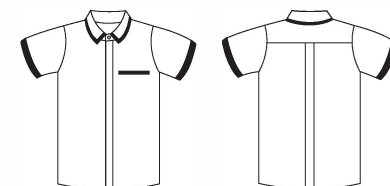

NHB 1900 - Smart Racewear

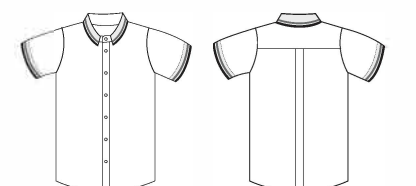

NHB 3000 - Cyril Shirt



Main Menu

# BUYER'S GUIDE

*Style Made Simple*

Choosing the right clothes isn't just about trends— it's about finding pieces that speak to who you are. This guide helps you navigate fabrics, fits, and functions to make confident choices that feel good and look better.

COLLECTIONS OF 2025 - 2027